

GRANSESIA

ISTRUZIONI D'USO PER L'UTENTE

LEGGERE ATTENTAMENTE E CONSERVARE CON
CURA ASSIEME AL MOBILE
(istruzioni originali)

INSTRUCTIONS POUR L'UTILISATEUR

LIRE AVEC ATTENTION CE MANUEL ET LE CONSERVER
PRÈS DU MEUBLE AVEC SOIN
(traduction de la notice originale)

USER INSTRUCTIONS

READ CAREFULLY AND KEEP WITH THE CABINET
(translation of the original instructions)

BETRIEBSANLEITUNG FÜR BETREIBER

SORGFÄLTIG LESEN UND MIT DEM MÖBEL AUFBEWAHREN
(Übersetzung der Originalanweisungen)

INSTRUCCIONES DE USO PARA EL USUARIO

LEER ATENTAMENTE Y CONSERVAR CON CUIDADO JUNTO
AL MUEBLE
(traducción de las instrucciones originales)

INSTRUÇÕES PARA O USO

LER COM ATENÇÃO E GUARDAR COM CUIDADO JUNTO AO MÓVEL
(tradução das instruções originais)

Modello - Modèle - Model Modell - Modelo - Modelo	GRANSESIA	COSTAN eptarefrigeration
Fabbricante - Constructeur - Manufacturer Hersteller - Fabricante - Fabricante	Epta Spa - Via Mecenate, 86 - 20138 Milano (MI) ITALIA Tel. 02/55403211 Telefax 02/55401023	1/20

INDICE

1.	Introduzione	2	IT
2.	Avvertenze di sicurezza	3	FR
2.1	Avvertenze generali	3	EN
2.2	Avvertenze per la Manutenzione del banco	4	DE
2.3	Avvertenze elettriche	5	ES
2.4	Divieti	5	PT
3.	Descrizione generale	6	
3.1	Sezioni	6	
4.	Trasporto del banco	7	
5.	Condizioni ambientali	8	
6.	Caratteristiche tecniche	9	
7.	Uso del banco	10	
8.	Manutenzione ordinaria	13	
8.1	Pulizia del banco	13	
9.	Indicazioni utente	14	
9.1	Descrizione del banco	14	
9.2	Trasporto e movimentazione	14	
9.3	Ricezione ed immagazzinamento	14	
9.4	Installazione e condizioni ambientali	15	
9.5	Collegamento elettrico	15	
9.6	Caratteristiche tecniche	15	
9.7	Caricamento del prodotto	15	
9.8	Uso del banco	16	
9.9	Pulizia e manutenzione ordinaria	16	
9.10	Situazioni di emergenza	18	
9.11	Assistenza tecnica	18	
9.12	Smantellamento ed eliminazione	18	
10.	Avvertenze generali integrative	19	

SIMBOLOGIA UTILIZZATA



Simbolo divieto: vieta di effettuare determinate operazioni.



Simbolo attenzione: norme antinfortunistiche per l'operatore.



Simbolo avvertenze: esiste la possibilità di arrecare danno al banco e/o ai suoi componenti.



Simbolo nota: fornisce informazioni utili.

Modello - Modèle - Model Modell - Modelo - Modelo	GRANSESIA	COSTAN eptarefrigeration
Fabbricante - Constructeur - Manufacturer Hersteller - Fabricante - Fabricante	Epta Spa - Via Mecenate, 86 - 20138 Milano (MI) ITALIA Tel. 02/55403211 Telefax 02/55401023	2/20

IT
FR
EN
DE
ES
PT

1. INTRODUZIONE

Si raccomanda di leggere attentamente il contenuto del presente Manuale e conservarlo unitamente al banco stesso.

Il costruttore declina ogni responsabilità per danni causati a persone o cose dovuti alla mancata osservanza delle avvertenze contenute in questo Manuale.



Il presente Manuale contiene informazioni ritenute necessarie per il buon uso e funzionamento del banco.

Al suo interno si trovano le seguenti descrizioni e informazioni:

- una descrizione funzionale del banco e di ogni sua parte
- informazioni sulla sicurezza del banco e le regole antinfortunistiche da seguire
- un corretto utilizzo del banco
- una corretta manutenzione ordinaria e programmata, comprese le operazioni di pulizia

Informazioni non contenute nel presente Manuale:

- Istruzioni di installazione

Per la corretta installazione del banco si faccia riferimento ai seguenti documenti:

- Technical Manual
- Quick Reference Instructions

Il presente Manuale è rivolto alle seguenti figure professionali:

- **OPERATORE QUALIFICATO** persona qualificata, istruita per il funzionamento, la regolazione, la pulizia e la manutenzione ordinaria del mobile
- **TECNICO SPECIALIZZATO** tecnico addestrato e autorizzato dall'ente indicato nel contratto (costruttore/concessionario/distributore) a eseguire: installazione, manutenzione straordinaria, riparazione, sostituzione e revisione del banco

Le istruzioni d'uso sono disponibili anche su: www.eptarefrigeration.com.

Fare riferimento alla dichiarazione di conformità per le normative e le certificazioni del banco.

Conservare sempre il libretto d'istruzione e in caso di vendita dell'apparecchio consegnarlo al nuovo proprietario.

Modello - Modèle - Model Modell - Modelo - Modelo	GRANSESIA	COSTAN <small>eptarefrigeration</small>
Fabbricante - Constructeur - Manufacturer Hersteller - Fabricante - Fabricante	Epta Spa - Via Mecenate, 86 - 20138 Milano (MI) ITALIA Tel. 02/55403211 Telefax 02/55401023	3/20

2. AVVERTENZE DI SICUREZZA

2.1 Avvertenze generali



Il costruttore declina ogni responsabilità per danni causati a persone o cose dovuti alla mancata osservanza delle avvertenze contenute in questo manuale. Qualsiasi persona utilizzi questo banco dovrà leggere il presente manuale d'uso.



Il datore di lavoro deve istruire il personale sui rischi da infortuni, sui dispositivi predisposti per la sicurezza del personale, sui rischi di emissione di rumore e sulle regole antinfortunistiche generali previste dalle norme in vigore.



Il banco deve essere utilizzato da persone adulte in possesso della conoscenza necessaria e le cui capacità fisiche, sensoriali o mentali non siano ridotte; il banco non è concepito per l'utilizzo da parte di minori (in particolare da 0 a 3 anni). I bambini, comunque sotto la sorveglianza e la responsabilità di adulti, non devono giocare con il banco.



Ogni altro uso non esplicitamente indicato in questo manuale è da considerarsi pericoloso ed il costruttore non può essere ritenuto responsabile per eventuali danni derivanti da uso improprio, erroneo ed irragionevole.



Il banco deve essere utilizzato da personale dotato degli opportuni dispositivi di protezione individuali.



È obbligatorio l'uso di guanti da lavoro.



Non lasciare esposto il banco agli agenti atmosferici.



Non utilizzare getti d'acqua diretti o indiretti sul banco.



Non toccare il banco con mani e piedi bagnati o umidi, non usare il banco a piedi nudi.



La rimozione di protezioni o pannellature che richiedono l'uso di utensili per essere rimosse è riservata esclusivamente al personale qualificato.



Per il montaggio di accessori opzionali dedicati, rivolgersi al più vicino centro di assistenza autorizzato.



Ogni intervento deve essere eseguito esclusivamente da personale qualificato e, in ogni caso, prima di ogni intervento si deve scollegare l'alimentazione elettrica del banco.

IT

FR

EN

DE

ES

PT

Modello - Modèle - Model Modell - Modelo - Modelo	GRANSESIA	COSTAN eptarefrigeration
Fabbricante - Constructeur - Manufacturer Hersteller - Fabricante - Fabricante	Epta Spa - Via Mecenate, 86 - 20138 Milano (MI) ITALIA Tel. 02/55403211 Telefax 02/55401023	4/20

IT
FR
EN
DE
ES
PT

 Istruire chiunque usi il banco sulla posizione dell'interruttore sezionatore.

 Gli interventi sul termostato sono riservati esclusivamente al personale tecnico di assistenza.

 Prestare attenzione alle parti calde o in movimento contrassegnate con l'apposito simbolo.

 In caso di incendio, non usare acqua per spegnere le fiamme ma solo estintori a secco.

 Non danneggiare il circuito refrigerante.

 Evitare fuochi o scintille all'interno dell'apparecchio.

 Mantenere libere da ostruzioni le aperture di ventilazione nell'involucro dell'apparecchio.

 Non utilizzare apparecchi elettrici all'interno degli scomparti dell'apparecchio per la conservazione dei cibi congelati se questi non sono del tipo raccomandato dal costruttore.

 Non conservare sostanze esplosive o pericolose, quali contenitori sotto pressione con propellente infiammabile, in questo apparecchio.

 Non lasciare pesi sopra il tetto del banco; è opportuno evitare di poggiare le derrate non imballate direttamente sui ripiani, ma utilizzare idonei contenitori per alimenti.

 Non posizionare contenitori di liquido e non versare liquidi sul banco.

2.2 Avvertenze per la Manutenzione del banco

 L'accesso a parti elettriche e/o parti che richiedono l'utilizzo di utensili è riservato a tecnici specializzati.

 Prima di qualsiasi operazione di manutenzione e pulizia riservate all'utente, togliere tensione al banco tramite l'interruttore sezionatore generale a parete.

 Prestare attenzione alle parti calde o in movimento contrassegnate con l'apposito simbolo.

 È obbligatorio l'uso di guanti da lavoro.

Modello - Modèle - Model Modell - Modelo - Modelo	GRANSESIA	COSTAN eptarefrigeration
Fabbricante - Constructeur - Manufacturer Hersteller - Fabricante - Fabricante	Epta Spa - Via Mecenate, 86 - 20138 Milano (MI) ITALIA Tel. 02/55403211 Telefax 02/55401023	5/20

2.3 Avvertenze elettriche



Accertarsi che la tensione di alimentazione corrisponda ai dati di targa del banco.



L'installazione elettrica deve essere eseguita a regola d'arte da tecnici specializzati.



La rimozione della copertura del quadro elettrico è riservata a tecnici specializzati.



Conformemente alle regole di installazione, la rete di alimentazione deve includere un dispositivo per la disconnessione omnipolare, che assicuri la disconnessione completa dalla rete nelle condizioni della categoria di sovratensione III.



L'installazione del banco deve essere effettuata secondo le istruzioni del costruttore, da personale professionalmente qualificato e conformemente alle norme sugli impianti elettrici vigenti nei singoli Paesi.



Un'errata installazione del banco può causare danni a persone, animali o cose, nei confronti dei quali il costruttore non può essere considerato responsabile.



Se il cavo di alimentazione è danneggiato, deve essere sostituito da personale tecnico di assistenza autorizzato. Non tentare la riparazione del cavo.



Non alimentare il banco se è danneggiato. In caso di dubbi, contattare il servizio di assistenza o il rivenditore.

2.4 Divieti



È fatto divieto di utilizzare dispositivi oltre a quelli forniti nel banco dal produttore, per accelerare il processo di sbrinamento.



È fatto divieto, da parte di personale non specializzato, di rimuovere la copertura del quadro elettrico o aprire pannellature che richiedano l'utilizzo di utensili.



È fatto divieto di utilizzare il banco per la conservazione e/o l'esposizione di sostanze esplosive, infiammabili o corrosive, come ad esempio bombolette spray con un propellente infiammabile.



È fatto divieto di utilizzare il banco per la conservazione e/o l'esposizione di prodotti farmaceutici.



È fatto divieto, in caso di PRODOTTI NON CONFEZIONATI O CONSERVATI A BASSA TEMPERATURA, di utilizzare il banco per la conservazione e/o l'esposizione di bottiglie ed imballi in vetro.



È fatto divieto di collocare il banco in ambienti in cui sono presenti sostanze gassose esplosive.



È fatto divieto di rimuovere la targa matricolare del banco.



È fatto divieto di salire sul banco o sul batticarrello del banco.

IT

FR

EN

DE

ES

PT

Modello - Modèle - Model Modell - Modelo - Modelo	GRANSESIA	COSTAN eptarefrigeration
Fabbricante - Constructeur - Manufacturer Hersteller - Fabricante - Fabricante	Epta Spa - Via Mecenate, 86 - 20138 Milano (MI) ITALIA Tel. 02/55403211 Telefax 02/55401023	6/20

IT
FR
EN
DE
ES
PT

3. DESCRIZIONE GENERALE

3.1 Sezioni

COMPACT

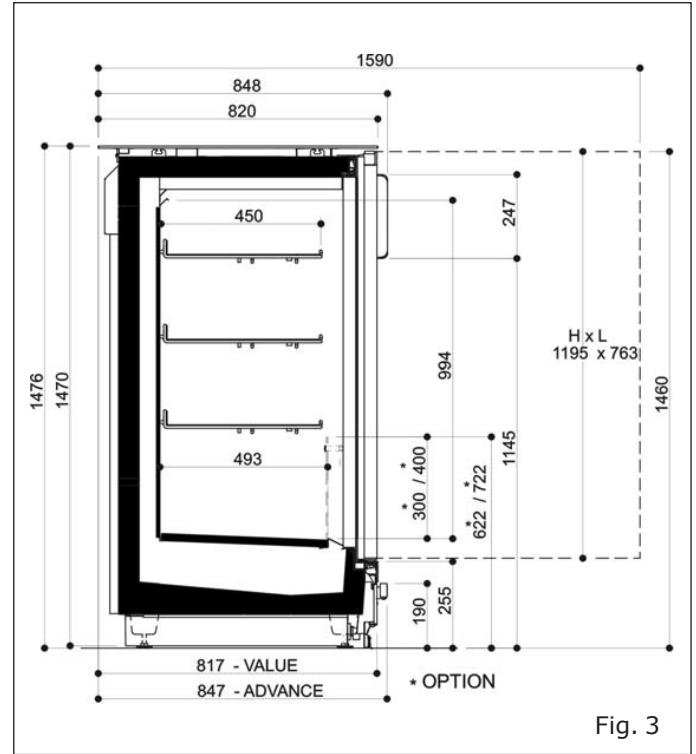

Fig. 3

NARROW

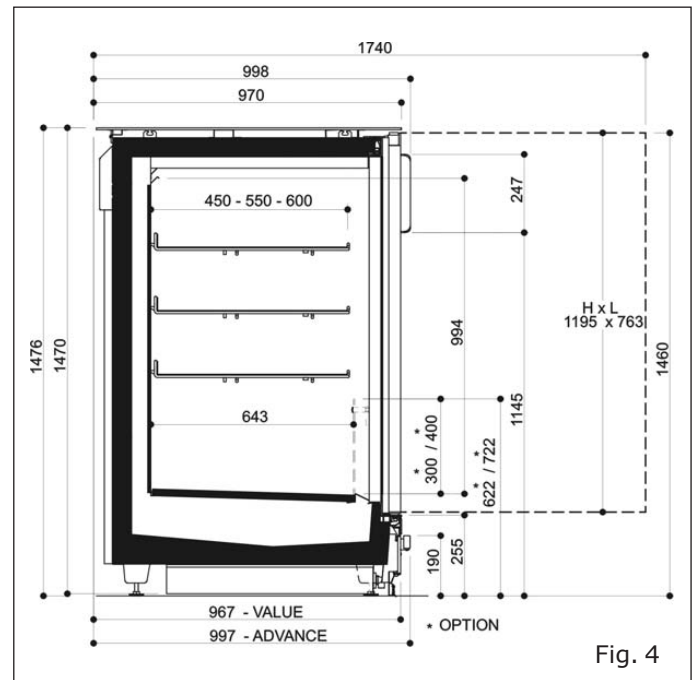

Fig. 4



Fig. 2

1. Targa dati
2. Interruttore luci
3. Illuminazione
4. Batticarrello (opzionale)
5. Termostato

Modello - Modèle - Model Modell - Modelo - Modelo	GRANSESIA	COSTAN eptarefrigeration
Fabbricante - Constructeur - Manufacturer Hersteller - Fabricante - Fabricante	Epta Spa - Via Mecenate, 86 - 20138 Milano (MI) ITALIA Tel. 02/55403211 Telefax 02/55401023	7/20

4. TRASPORTO DEL BANCO



1. Punti di sollevamento

Tab. I

Modello		Peso (kg)	Peso con imballo (kg)
2D	COMPACT	350	490
3D		500	550
2D EOL		350	490
2D	NARROW	350	490
3D		500	550
EOL 3D-S		500	550

Modello - Modèle - Model Modell - Modelo - Modelo	GRANSESIA	COSTAN eptarefrigeration
Fabbricante - Constructeur - Manufacturer Hersteller - Fabricante - Fabricante	Epta Spa - Via Mecenate, 86 - 20138 Milano (MI) ITALIA Tel. 02/55403211 Telefax 02/55401023	8/20

IT
FR
EN
DE
ES
PT

5. CONDIZIONI AMBIENTALI



Fig. 7



Fig. 9

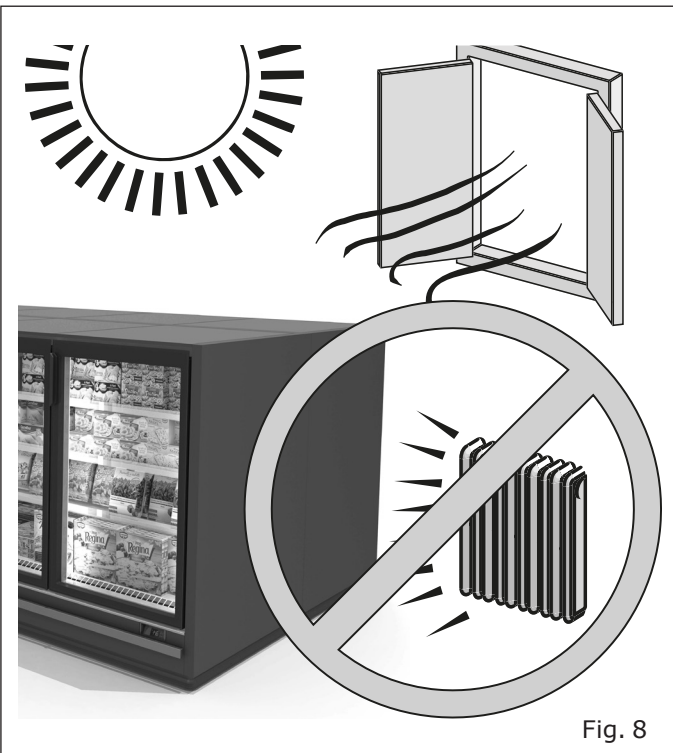

Fig. 8

Tab. II

Caratteristiche	
Tipo di locale	Chiuso
Temperatura	25°C
Umidità relativa	60 %
Illuminazione	600 lx

Modello - Modèle - Model Modell - Modelo - Modelo	GRANSESIA	COSTAN eptarefrigeration
Fabbricante - Constructeur - Manufacturer Hersteller - Fabricante - Fabricante	Epta Spa - Via Mecenate, 86 - 20138 Milano (MI) ITALIA Tel. 02/55403211 Telefax 02/55401023	9/20

6. CARATTERISTICHE TECNICHE







 <small>EPTA S.p.A. Via Mecenate, 86 20138 Milano - Italy</small>		12
1	2	SN 13  14 REF 15 16
RATED BEMESSUNG ASSIGNÉ NOMINALE NOMINAL	3 4 5 6	REFRIGERANT KÄLTEMITTEL RÉFRIGÉRANT REFRIGÉRANTE REFRIGERANTE
	7 8	17 18 19 20
DEFROSTING ABTAUUNG DÉGIVRAGE SBRINAMENTO DESCONGELAMIENTO	7 8	CLIMATIC CLASS KLIMAKLASSE CLASSE CLIMATICA CLASSE CLIMATICA CLASE CLIMÁTICA
HEATING SYSTEMS HEIZUNGSSYSTEME SYSTEMES CHAUFFANTS SISTEMI DI RISCALDAMENTO SISTEMA DE CALEFACCIÓN	9	INSULATION BLOWING GAS ISOLATIONSGAS (BLÄHGAS) AGENT MOUSSANT D' ISOLATION GAS ESPANDENTE ISOLAMENTO AGENTE ESPUMANTE
	10	PROTECTION INDEX SCHUTZART INDEX DE LA PROTECTION INDICE DI PROTEZIONE ÍNDICE DE PROTECCIÓN
 <small>Read Operator's Manual available at www.eptarefrigeration.com or calling +39 0437 968379</small>	11	24  

Fig. 10

- | | |
|---|---|
| <ol style="list-style-type: none"> 1. Origine del prodotto 2. Prodotto in "Paese di origine" 3. Tensione nominale 4. Potenza nominale 5. Frequenza nominale 6. Corrente Nominale 7. Potenza di sbrinamento 8. Corrente di sbrinamento 9. Sistema di riscaldamento 10. Sistema di illuminazione 11. Manuale dell'operatore 12. Codice a barre 13. Numero di serie | <ol style="list-style-type: none"> 14. Data di produzione 15. Hat Code 16. Modello 17. Tipo di refrigerante 1 18. Massa refrigerante 1 19. Tipo di refrigerante 2 20. Massa refrigerante 2 21. Classe climatica 22. Isolamento gas 23. Indice di protezione 24. Marchi di certificazione 25. Marchio RAEE |
|---|---|





È obbligatorio l'uso di divisori interni tra ripiani e alla base per assicurare il corretto funzionamento del banco. Per la versione a 3 i divisori sono forniti di serie.

Modello - Modèle - Model Modell - Modelo - Modelo	<h1>GRANSESIA</h1>	
Fabbricante - Constructeur - Manufacturer Hersteller - Fabricante - Fabricante	Epta Spa - Via Mecenate, 86 - 20138 Milano (MI) ITALIA Tel. 02/55403211 Telefax 02/55401023	10/20

IT
FR
EN
DE
ES
PT

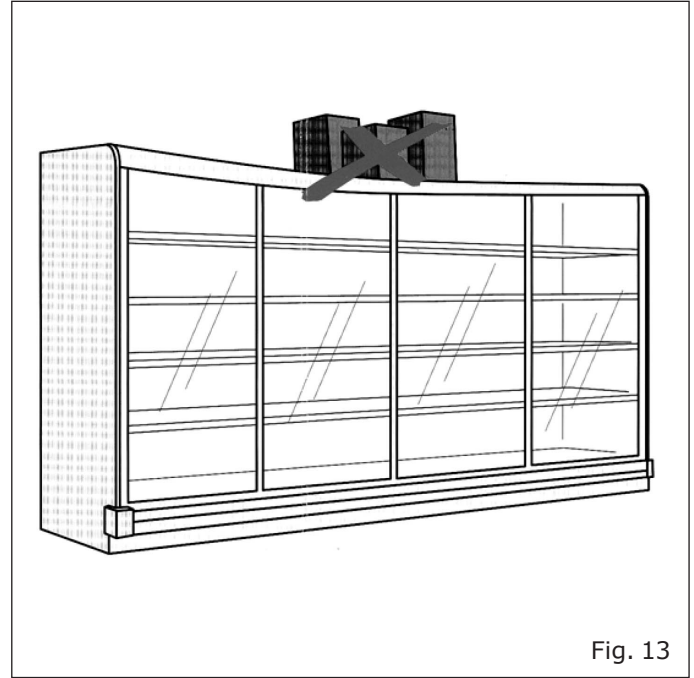
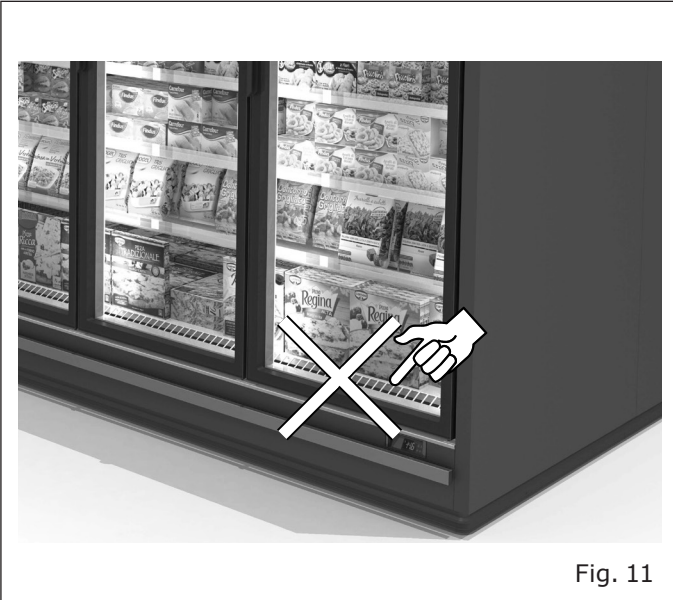
7. USO DEL BANCO



 Non coprire

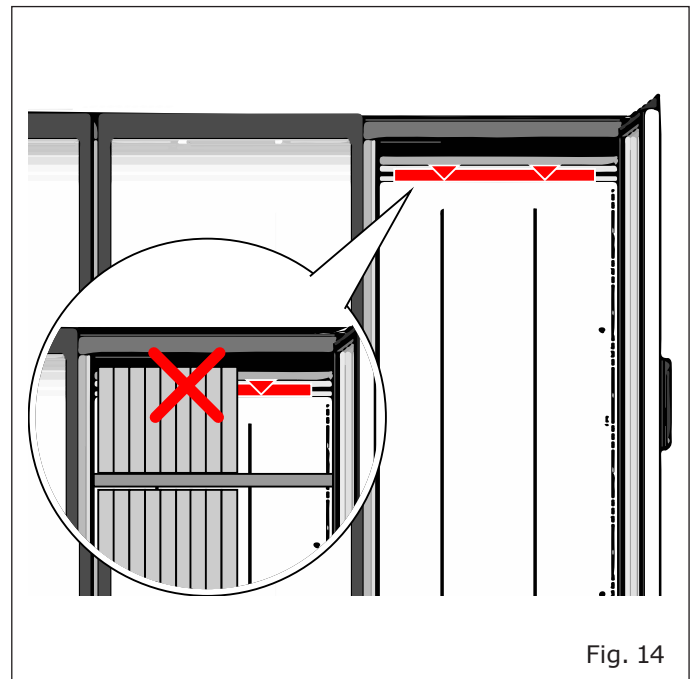
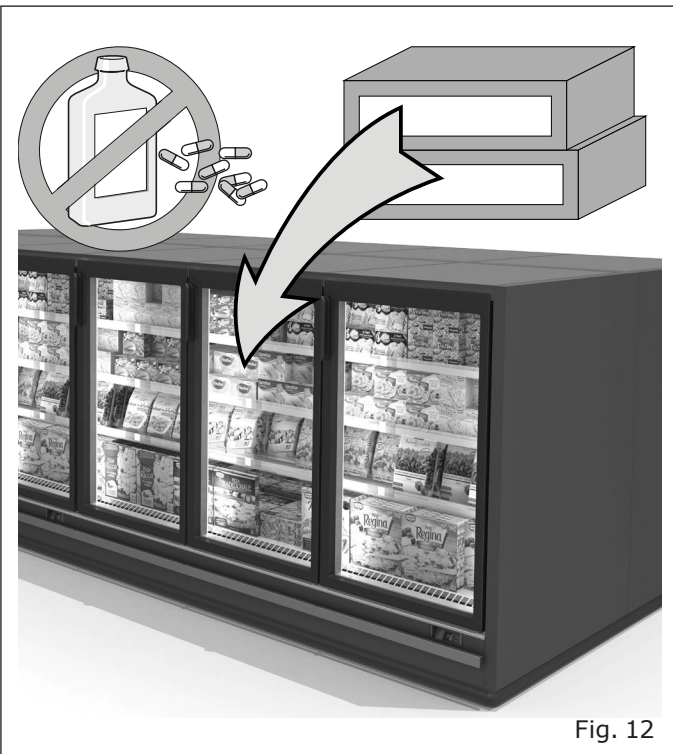

 Rispettare la linea di carico

Modello - Modèle - Model Modell - Modelo - Modelo	<h1>GRANSESIA</h1>	
Fabbricante - Constructeur - Manufacturer Hersteller - Fabricante - Fabricante	Epta Spa - Via Mecenate, 86 - 20138 Milano (MI) ITALIA Tel. 02/55403211 Telefax 02/55401023	11/20

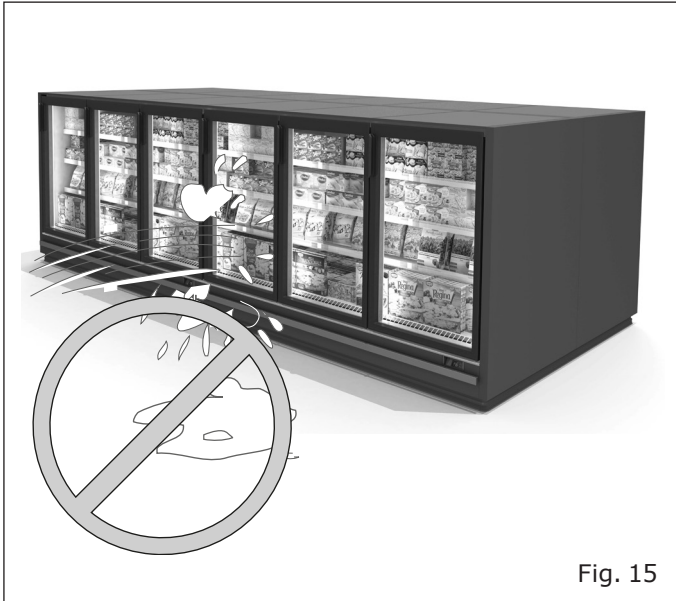

Fig. 15

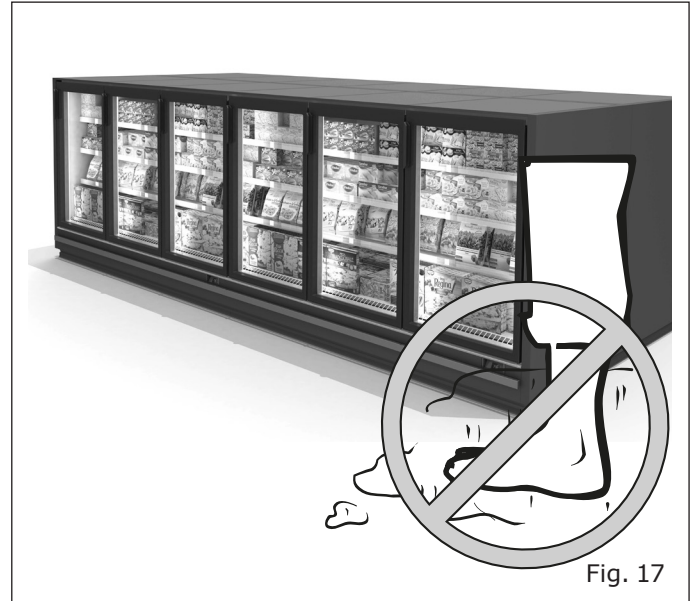

Fig. 17

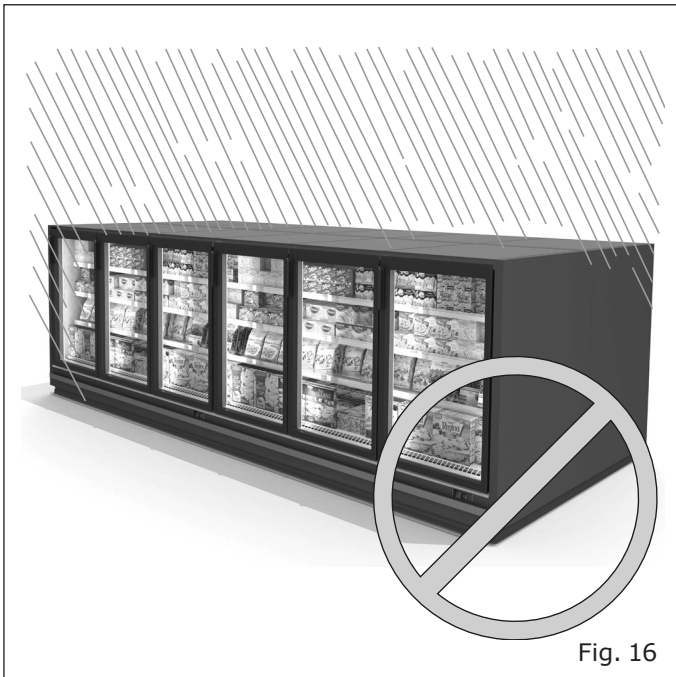

Fig. 16

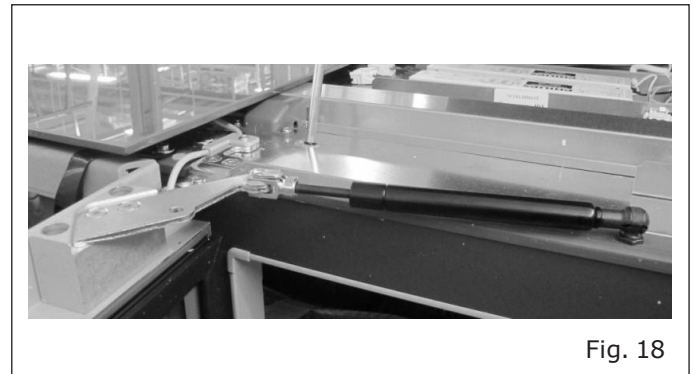

Fig. 18



Fig. 19

- IT
- FR
- EN
- DE
- ES
- PT

Modello - Modèle - Model Modell - Modelo - Modelo	<h1>GRANSESIA</h1>	
Fabbricante - Constructeur - Manufacturer Hersteller - Fabricante - Fabricante	Epta Spa - Via Mecenate, 86 - 20138 Milano (MI) ITALIA Tel. 02/55403211 Telefax 02/55401023	12/20

IT
FR
EN
DE
ES
PT



Fig. 20

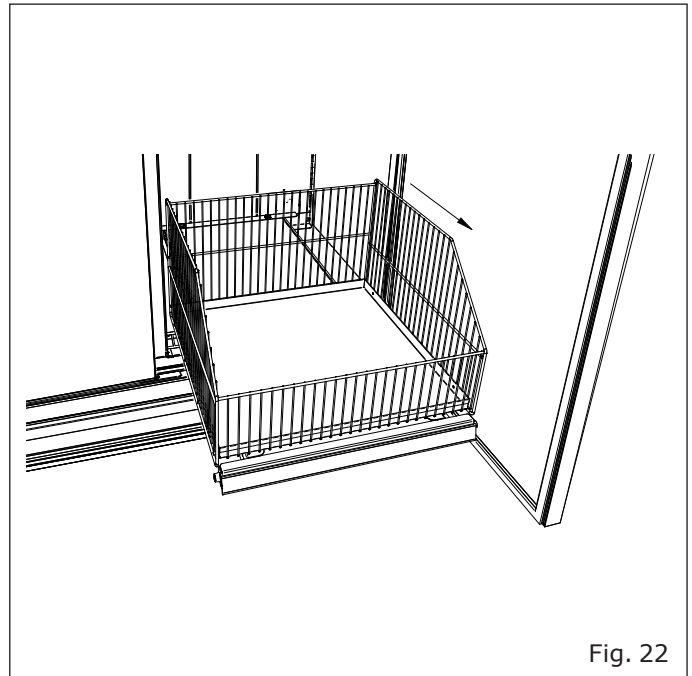

Fig. 22



Fig. 21

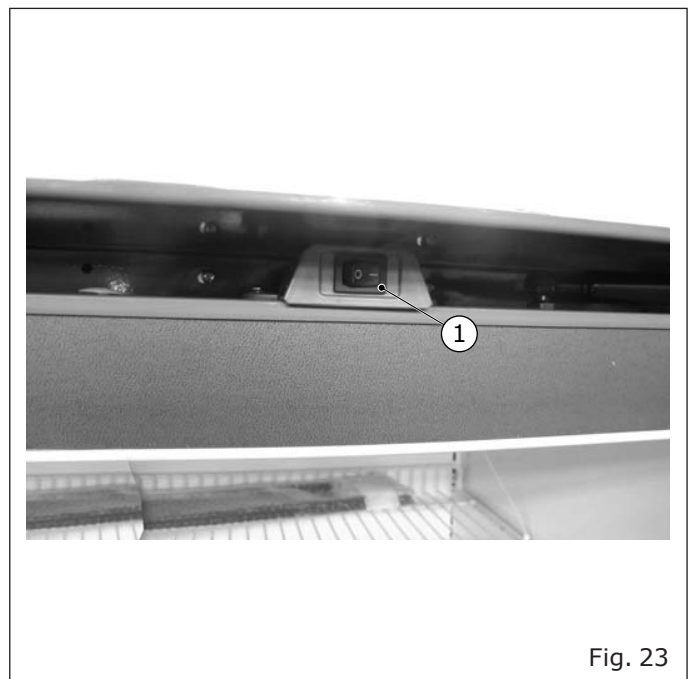

Fig. 23

1. Interruttore illuminazione

Modello - Modèle - Model Modell - Modelo - Modelo	<h1>GRANSESIA</h1>	
Fabbricante - Constructeur - Manufacturer Hersteller - Fabricante - Fabricante	Epta Spa - Via Mecenate, 86 - 20138 Milano (MI) ITALIA Tel. 02/55403211 Telefax 02/55401023	13/20

8. MANUTENZIONE ORDINARIA

8.1 Pulizia del banco

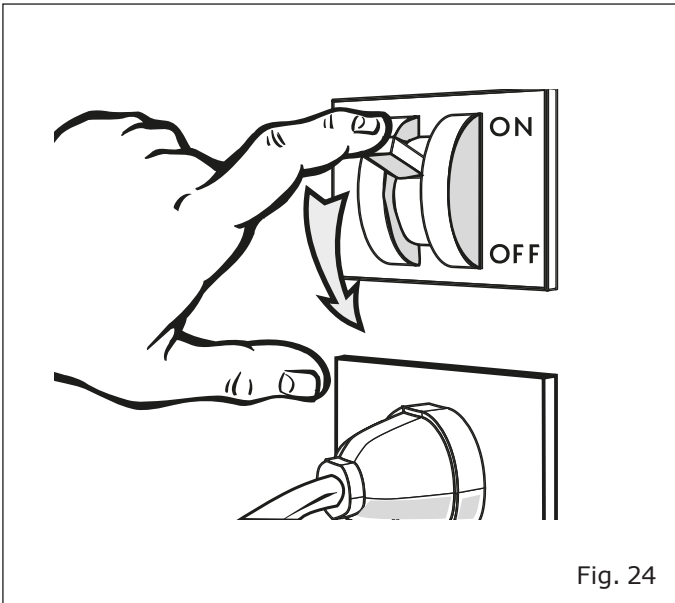

Fig. 24



Fig. 25

- IT
- FR
- EN
- DE
- ES
- PT

Modello - Modèle - Model Modell - Modelo - Modelo	GRANSESIA	COSTAN eptarefrigeration
Fabbricante - Constructeur - Manufacturer Hersteller - Fabricante - Fabricante	Epta Spa - Via Mecenate, 86 - 20138 Milano (MI) ITALIA Tel. 02/55403211 Telefax 02/55401023	14/20

9. INDICAZIONI UTENTE

9.1 Descrizione del banco

Questa linea di banchi è adatta alla conservazione ed esposizione di gelati e surgelati.

CLASSE DI TEMPERATURA (secondo EN ISO 23953-2): 3L1.

Le caratteristiche generali e le dimensioni sono illustrate nelle figure e nelle sezioni contenute in "Descrizione generale" (a pag. "7").

Durante le fasi di trasporto e movimentazione, ricezione e immagazzinamento, installazione, caricamento, uso, pulizia e manutenzione, smantellamento, prestare attenzione al rischio di ribaltamento del banco ("Fig. 26").

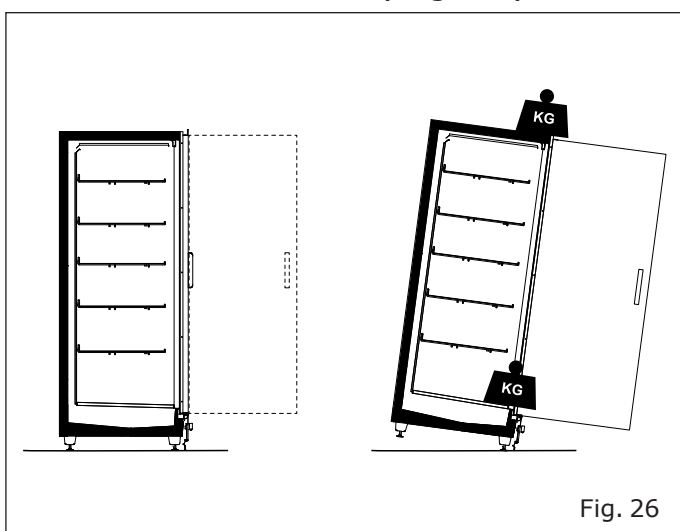

Fig. 26

9.2 Trasporto e movimentazione

Il banco è contenuto in uno specifico imballo provvisto di pedana per la movimentazione con carrelli a forza.

Per il trasporto e la movimentazione del banco utilizzare:

- Esclusivamente una pedana apposita o equivalente
- Un carrello elevatore a mano o elettrico adatto al sollevamento del banco, con caratteristiche idonee nel rispetto delle Norme vigenti

I pesi del banco (vuoto e con imballo) e le dimensioni dell'imballo sono riportati in "Trasporto del banco" (tabella "Tab. I" e figure a pag. "8").

Le operazioni di movimentazione devono essere svolte da personale qualificato, in grado di valutare pesi, punti di sollevamento e mezzi più idonei sia per sicurezza che per portata.

9.3 Ricezione ed immagazzinamento

Controllare le condizioni dell'imballo prima di prendere in consegna il banco dal trasportatore. Se ci sono danni evidenti nell'imballo:

- Rimuovere l'imballo del banco in presenza del trasportatore.
- Firmare con riserva il documento di consegna.

Il costruttore non risponde di eventuali danni dovuti al trasporto o ad un errato stoccaggio del banco.

Il banco deve essere conservato in un luogo riparato da sole ed intemperie, con una temperatura compresa tra -25°C e +55°C e un'umidità relativa dell'aria compresa tra 30% e 95%.

Modello - Modèle - Model Modell - Modelo - Modelo	GRANSESIA	
Fabbricante - Constructeur - Manufacturer Hersteller - Fabricante - Fabricante	Epta Spa - Via Mecenate, 86 - 20138 Milano (MI) ITALIA Tel. 02/55403211 Telefax 02/55401023	15/20

9.4 Installazione e condizioni ambientali

Il banco non è progettato per un'installazione da esterno.

Per un corretto funzionamento del banco, verificare che sia posizionato:

- Su un pavimento livellato ("Fig. 7").
- Lontano da fonti di calore, dalla radiazione diretta del sole, da porte, finestre, ventilatori e bocche di aerazione ("Fig. 8").

Assicurare lo spazio necessario all'uso del banco da parte della clientela.

Le condizioni dell'ambiente in cui porre il banco sono riportate in "Condizioni ambientali".

9.5 Collegamento elettrico

A monte del banco deve essere installato un interruttore sezionatore omipolare. Questo deve avere:

- Distanza minima dei contatti di 3 mm.
- Potere di interruzione adeguato

L'interruttore sezionatore deve essere posto in una posizione tale da renderlo facilmente azionabile in situazioni di emergenza (distanza massima di 3 m).

Prima di collegare il banco, accertarsi che la tensione di alimentazione corrisponda ai dati di targa del banco. Per garantire un funzionamento regolare, la variazione massima di tensione deve essere compresa tra +/- 6% del valore nominale.

9.6 Caratteristiche tecniche

La targa matricolare riporta i dati tecnici caratteristici del banco. La sua posizione e la tipologia di dati sono riportati in "Caratteristiche tecniche" ("Fig. 10").

Schemi elettrici, distinte di taratura degli strumenti di controllo, istruzioni di Installazione e copia della Dichiarazione di Conformità sono disponibili sul sito <https://documents.eptarefrigeration.com>.

Il livello di pressione sonora generato dal funzionamento del banco è inferiore a 70 dB(A). Il banco non provoca vibrazioni dannose.

9.7 Caricamento del prodotto

Dare tensione al banco per dare inizio al suo ciclo di raffreddamento, agendo sull'interruttore sezionatore generale a parete. Dopo circa 2 ore è possibile caricare il banco.

Il banco è atto a conservare la temperatura della merce e non ad abbatterla; le derrate, quindi, devono essere introdotte al suo interno solo se già raffreddate alle loro rispettive temperature di conservazione. Prodotti che abbiano subito un riscaldamento non devono mai essere introdotti nel banco.

In presenza di vetri frontali sul banco, si consiglia di effettuare il caricamento della merce quando nello spazio di vendita non è presente la clientela.

Nel caricamento della merce, fare in modo che:

- Il carico sia omogeneo per dimensione e qualità della merce stessa
- La merce non ostruisca il corretto flusso d'aria refrigerata ("Fig. 11").
- La merce non superi la linea di carico ("Fig. 14").

Carico massimo ammissibile uniformemente distribuito:

- Sui ripiani: 160 kg/m²
- Sul piano di fondo: 225 kg/m²

IT

FR

EN

DE

ES

PT

Modello - Modèle - Model Modell - Modelo - Modelo	GRANSESIA	COSTAN <small>eptarefrigeration</small>
Fabbricante - Constructeur - Manufacturer Hersteller - Fabricante - Fabricante	Epta Spa - Via Mecenate, 86 - 20138 Milano (MI) ITALIA Tel. 02/55403211 Telefax 02/55401023	16/20

IT
FR
EN
DE
ES
PT



La porta è stata progettata per rimanere aperta **SENZA ALCUN SISTEMA DI BLOCCO MECCANICO**, semplicemente aprendola di 90°. Inoltre, il sistema di chiusura "soft-closing" assicura una chiusura automatica lenta e gentile nella parte finale senza il bisogno di forzarne la chiusura. Per questo **NON È NECESSARIO APRIRE** la porta oltre i 90° e bloccarla con pesi o **MANTENERLA** in posizione se è già di per sè aperta a 90° ("Fig. 19, "Fig. 21").



Durante la fase di caricamento, se in presenza di cesti scorrevoli (opzionali), non devono essere estratti tutti contemporaneamente ("Fig. 22").

9.8 Uso del banco

illuminazione

L'illuminazione del banco è comandata da un interruttore posto sul banco in alto a destra.

Termostato/termometro

Sul banco in basso a destra è posizionato un termostato/termometro remoto per il controllo della temperatura.

9.9 Pulizia e manutenzione ordinaria

Si consiglia una buona visibilità nella zona di intervento, eventualmente servendosi di una ulteriore fonte di illuminazione.



Rivestimento anti-appannamento delle porte **LOW CONSUMPTION**. Le porte del mobile hanno un rivestimento anti-appannamento che previene il formarsi di appannamento in qualsiasi condizione di temperatura e umidità, anche dopo prolungate immersioni in acqua o frequenti puliture. Estremamente idrofilico, il rivestimento produce goccioline d'acqua che si propagano e non si trasformano, quindi, in appannamento. Pur assorbendo l'umidità, il rivestimento non si scioglie in acqua e, di conseguenza, non si macchia se bagnato. La pellicola non viene danneggiata da detergenti commerciali per vetro, smacchiatori, ammoniaci, alcool e benzina e non scolorisce se esposta al sole o al calore.

Le porte vengono fornite con il rivestimento antiappannamento laminato sul vetro interno e protetta da un layer.

Il layer protettivo è parzialmente sollevato sui lati per agevolarne la rimozione in fase di utilizzo. La rimozione del layer protettivo deve avvenire dopo l'installazione delle porte sul banco una volta che il banco ha raggiunto la temperatura di utilizzo, questo per consentire l'immediato funzionamento della pellicola anti-appannamento.

Per richiamare questo passaggio, sulla pellicola protettiva è apposta la seguente etichetta: "DO NOT REMOVE THE PROTECTIVE FILM UNTIL THE CABINET HAS REACHED THE OPERATING TEMPERATURE".

Modello - Modèle - Model Modell - Modelo - Modelo	GRANSESIA	COSTAN eptarefrigeration
Fabbricante - Constructeur - Manufacturer Hersteller - Fabricante - Fabricante	Epta Spa - Via Mecenate, 86 - 20138 Milano (MI) ITALIA Tel. 02/55403211 Telefax 02/55401023	17/20

Pulizia del banco

Utilizzare esclusivamente acqua a temperatura massima di 65°C e sapone o detergente neutro di uso domestico diluito in acqua.

Per le superfici vetrate usare unicamente prodotti per la pulizia dei vetri. Si consiglia di evitare l'uso di acqua in quanto può depositare calcare sulla superficie del vetro.

Non utilizzare assolutamente:

- Spugne abrasive
- Prodotti infiammabili o abrasivi come alcool, acetone o solventi
- Detergenti che contengono tensioattivi non ionici, limone o aceto (acido acetico)



Non lavare o pulire con acqua o liquidi la parte superiore del banco.

Pulire **UNA VOLTA A SETTIMANA** tutte le parti esterne del banco.

Pulire **UNA VOLTA AL MESE** tutte le parti interne del banco, seguendo le istruzioni sotto riportate:

- Togliere la tensione elettrica al banco tramite l'interruttore sezionatore generale a parete ("Fig. 24").
- Svuotare il banco, stoccando la merce in celle o refrigeratori atti a mantenerne la temperatura di conservazione.
- Attendere che l'interno del banco abbia raggiunto la temperatura ambiente e procedere alla pulizia
- Dopo aver controllato attentamente che l'interno del banco sia completamente asciutto, rimettere in funzione l'apparecchio ridando tensione al banco.
- Dopo circa un paio d'ore caricare nuovamente la merce.

Quando si mette fuori servizio il banco, scollegare l'alimentazione e seguire i passaggi precedenti, lasciando gli sportelli aperti (se presenti) per evitare cattivi odori.

Procedere **OGNI TRE MESI** allo sbrinamento del banco per permettere lo scioglimento del ghiaccio che si può essere formato sulle alette dell'evaporatore impedendone il corretto funzionamento. La durata e il numero di sbrinamenti sono regolati direttamente in fabbrica. Eventuali regolazioni sono riservate esclusivamente al servizio tecnico di assistenza. L'acqua di sbrinamento viene raccolta da un apposito scarico. Verificare periodicamente che l'acqua di sbrinamento defluisca normalmente. Se così non fosse intervenire mediante una sonda flessibile non appuntita.

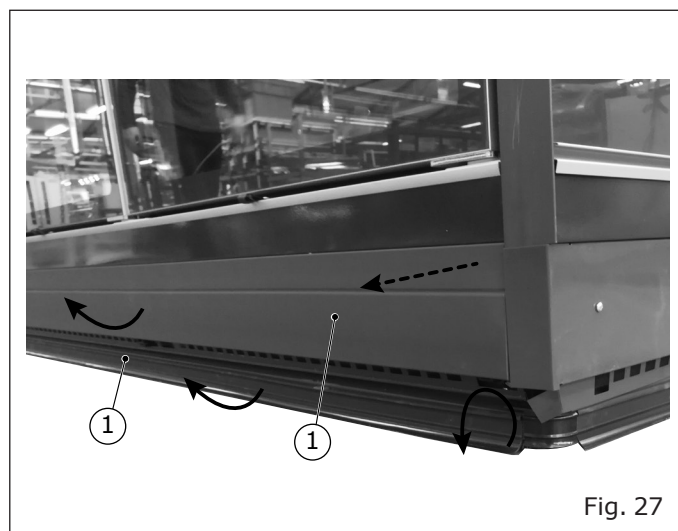

Fig. 27

1. Rimuovere

Agire come indicato per la pulizia **MENSILE** delle parti interne, ma in questo caso si dovrà prevedere un tempo di attesa più lungo per permettere il completo scioglimento del ghiaccio.

IT

FR

EN

DE

ES

PT

Modello - Modèle - Model Modell - Modelo - Modelo	GRANSESIA	COSTAN eptarefrigeration
Fabbricante - Constructeur - Manufacturer Hersteller - Fabricante - Fabricante	Epta Spa - Via Mecenate, 86 - 20138 Milano (MI) ITALIA Tel. 02/55403211 Telefax 02/55401023	18/20

IT

9.10 Situazioni di emergenza

FR

Il banco non parte o si arresta:

EN

- Verificare che non vi sia una situazione di blackout elettrico.
- Controllare che l'interruttore generale a parete sia acceso.
- Controllare che la spina del banco sia inserita nella presa di corrente.

DE

ES

PT

Se l'interruzione elettrica non dipende da questi motivi, rivolgersi al più vicino centro di assistenza autorizzato e procedere allo svuotamento completo ed allo stoccaggio immediato del prodotto in celle o refrigeratori atti a mantenerne la temperatura di conservazione.

Il banco non raffredda a sufficienza:

- Controllare che il caricamento del banco sia corretto.
- Sbrinare il banco per poi riprendere il funzionamento normale, se questa operazione non viene effettuata da più di tre mesi.
- Controllare che il banco non sia vicino a fonti di calore o correnti d'aria.
- Verificare le condizioni ambientali riportate in "Condizioni ambientali" ("Tab. II").
- Controllare, tramite una livella, la planarità del banco.

Se il mancato raffreddamento persiste, rivolgersi al più vicino centro di assistenza autorizzato.

Il banco è rumoroso:

- Controllare che viti e bulloni siano perfettamente chiusi.
- Controllare, tramite una livella, la planarità del banco.

Se l'inconveniente persiste, rivolgersi al più vicino centro di assistenza autorizzato.

9.11 Assistenza tecnica

Qualora si rendesse necessario l'intervento del personale tecnico di assistenza, contattare immediatamente il fornitore presso il quale è stato acquistato il banco.

Qualora vi fosse la necessità di usare pezzi di ricambio fare sempre riferimento al servizio tecnico di assistenza: chiedere ed accertarsi che vengano utilizzati ricambi originali.

9.12 Smantellamento ed eliminazione

In conformità alle norme per lo smantellamento dei rifiuti vigenti nei singoli Paesi e per il rispetto dell'ambiente in cui viviamo, vi preghiamo di dividere le parti del banco in modo da poterle smaltire separatamente o eventualmente recuperarle opportunamente.

Tutte le parti componenti il banco non sono assimilabili ai rifiuti solidi urbani fatta eccezione per le parti metalliche che comunque non figurano tra i rifiuti speciali per la maggior parte dei Paesi Europei.



Il sistema di refrigerazione è ad alta pressione. Contattare personale esperto prima della rottamazione.

I componenti del circuito di refrigerazione non devono essere tagliati e/o separati prima che venga scaricato il circuito, con recupero del gas refrigerante da parte di personale qualificato.

Modello - Modèle - Model Modell - Modelo - Modelo	GRANSESIA	COSTAN eptarefrigeration
Fabbricante - Constructeur - Manufacturer Hersteller - Fabricante - Fabricante	Epta Spa - Via Mecenate, 86 - 20138 Milano (MI) ITALIA Tel. 02/55403211 Telefax 02/55401023	19/20

10. AVVERTENZE GENERALI INTEGRATIVE

Istruzioni per la corretta installazione e manutenzione

Le istruzioni di uso e manutenzione si trovano nel Manuale Utente disponibile nel sito: www.eptarefrigeration.com.

Le istruzioni di installazione dedicate al personale esperto sono disponibili:

- Presso la rete di assistenza.
- In alcune categorie di prodotto in forma cartacea consegnato insieme al prodotto.

Servizi professionali di riparazione

I servizi sono erogati dalla nostra rete di assistenza consultabile nell'area contatti all'indirizzo web www.eptarefrigeration.com.

Parti di ricambio

Le parti di ricambio e le informazioni per la riparazione dell'apparecchio sono disponibili per almeno 8 anni dopo che il prodotto viene dichiarato fuori produzione al seguente indirizzo web: www.epta-service.com/service.

Le credenziali di accesso sono fornite su richiesta da inviare via mail a: servicesupport@eptarefrigeration.com.

Pulizia del condensatore ad aria

Le apparecchiature a gruppo incorporato con condensazione ad aria mantengono la loro efficienza solo se la pulizia del condensatore è eseguita nei modi e nei tempi indicati nel manuale di uso e manutenzione.

Informazione importante sugli sprechi alimentari

Si raccomanda di seguire attentamente le istruzioni di conservazione riportate nelle confezioni dei prodotti e le indicazioni fornite dai produttori di alimenti.

Pertanto, le impostazioni di temperatura devono essere adeguate alle caratteristiche di conservazione dei prodotti alimentari coerentemente con le indicazioni riportate nella nostra documentazione tecnica.

Utilizzi non corretti possono causare un deperimento.

Condizioni ambientali

Il presente apparecchio è destinato a funzionare in ambienti in cui la temperatura e l'umidità rientrano nei limiti previsti nel Manuale di uso e manutenzione.

Istruzioni per il disassemblaggio

Per il disassemblaggio occorre rivolgersi ad operatori professionali.

Il gruppo Epta, da sempre animato da una particolare attenzione per l'ambiente, mette a disposizione degli utenti i manuali di smantellamento e trattamento dei rifiuti dei banchi frigoriferi plug-in, scaricabili di seguito.

- Manuale di smantellamento banchi plug-in aperti:



- Manuale di smantellamento banchi plug-in chiusi:



Altre informazioni

Per ulteriori e più dettagliate informazioni si prega di fare riferimento a www.eptarefrigeration.com ed a EPREL a cui si accede attraverso il QR code qui o nell'etichetta energetica del prodotto.



Modello - Modèle - Model Modell - Modelo - Modelo	GRANSESIA	COSTAN <small>eptarefrigeration</small>
Fabbricante - Constructeur - Manufacturer Hersteller - Fabricante - Fabricante	Epta Spa - Via Mecenate, 86 - 20138 Milano (MI) ITALIA Tel. 02/55403211 Telefax 02/55401023	20/20

IT

Limiti di applicazione

FR

EN

DE

ES

PT



Questo banco è progettato per l'utilizzo, il trasporto e l'immagazzinamento fino ad un'altitudine massima di 2000 m sul livello del mare.

Immagazzinamento:

- Temperatura compresa tra 15°C e 50°C.
- Umidità relativa compresa tra 20% e 90%.
- Tempo massimo 6 mesi.

Trasporto:

- Temperatura compresa tra 20°C e 70°C.
- Umidità relativa compresa tra 20% e 90%.
- Tempo massimo 2 mesi.

Installazione:

- Temperatura compresa tra 0°C e 40°C.
- Umidità relativa compresa tra 20% e 90%.
- Tempo massimo 2 mesi.

Utilizzo:

Le prestazioni del banco non sono garantite al di fuori del suo normale utilizzo.

È garantita la sua integrità e sicurezza entro i seguenti limiti per condizioni temporanee.

Ambiente all'esterno del banco:

- Da classe 1 (16°C / 80%rh) a classe 4 (30°C / 55%rh) o classe 6 (27°C / 70%rh).

Ambiente interno al banco (condizioni per la sicurezza elettrica):

Banco a temperatura positiva

- Temperatura compresa tra -10°C e +10°C.
- Umidità relativa compresa tra 70% e 100%.
- Tempo massimo 10 anni.

Banco a temperatura negativa

- Temperatura compresa tra -40°C e 15°C.
- Umidità relativa compresa tra 90% e 100%.
- Tempo massimo 10 anni.



Durante il funzionamento delle resistenze si potrebbero registrare localmente delle temperature superiori ai suddetti limiti, comunque nel rispetto delle condizioni di sicurezza.

Modello - Modèle - Model Modell - Modelo - Modelo	GRANSESIA	COSTAN eptarefrigeration
Fabbricante - Constructeur - Manufacturer Hersteller - Fabricante - Fabricante	Epta Spa - Via Mecenate, 86 - 20138 Milano (MI) ITALIA Tel. 02/55403211 Telefax 02/55401023	1/20

TABLE DES MATIÈRES

1.	Introduction	2
2.	Avertissements de sécurité	3
2.1	Avertissements généraux	3
2.2	Avertissements pour l'entretien du meuble réfrigéré	4
2.3	Avertissements électriques	5
2.4	Interdictions	5
3.	Description générale	6
3.1	Vues en coupe	6
4.	Transport du meuble réfrigéré	7
5.	Conditions ambiantes	8
6.	Caractéristiques techniques	9
7.	Utilisation du meuble réfrigéré	10
8.	Entretien ordinaire	13
8.1	Nettoyage du meuble réfrigéré	13
9.	Indications utilisateur	14
9.1	Descriptions du meuble réfrigéré	14
9.2	Transport et déplacement	14
9.3	Réception et stockage	14
9.4	Installation et conditions ambiantes	15
9.5	Connexion électrique	15
9.6	Caractéristiques techniques	15
9.7	Chargement du produit	15
9.8	Utilisation du meuble réfrigéré	16
9.9	Nettoyage et entretien ordinaire	16
9.10	Situations d'urgence	18
9.11	Service après-vente	18
9.12	Démantèlement et élimination	18
10.	Avertissements généraux supplémentaires	19

SYMBOLOGIE UTILISÉE



Symbole d'interdiction: interdiction d'effectuer certaines opérations.



Symbole d'attention: normes anti-accident pour l'opérateur.



Symbole d'avertissement: risque d'endommager le meuble réfrigéré et/ou ses composants.



Symbole de remarque: fourniture d'informations utiles.

Modello - Modèle - Model Modell - Modelo - Modelo	GRANSESIA	COSTAN eptarefrigeration
Fabbricante - Constructeur - Manufacturer Hersteller - Fabricante - Fabricante	Epta Spa - Via Mecenate, 86 - 20138 Milano (MI) ITALIA Tel. 02/55403211 Telefax 02/55401023	2/20

IT

1. INTRODUCTION

FR

Veillez lire attentivement ce manuel et le conserver avec le meuble réfrigéré.

EN

Le constructeur décline toute responsabilité pour tout préjudice causé aux personnes ou aux biens, dû au non-respect des consignes indiquées dans ce manuel.

DE

ES

PT



Ce manuel fournit les informations considérées comme nécessaires pour une utilisation correcte et un bon fonctionnement du meuble réfrigéré.

Il contient les descriptions et les informations suivantes:

- une description fonctionnelle du meuble réfrigéré et de chacune de ses parties
- des informations concernant la sécurité du meuble réfrigéré et les règles anti-accident auxquelles se conformer
- une utilisation correcte du meuble réfrigéré
- un bon entretien ordinaire et programmé, y compris les opérations de nettoyage

Informations non contenues dans ce manuel:

- Instructions d'installation

Pour une installation correcte du meuble réfrigéré, veuillez faire référence aux documents suivants:

- Manuel technique
- Instructions de référence rapides

Ce manuel s'adresse aux professionnels suivants:

- **OPÉRATEUR QUALIFIÉ** personne qualifiée, instruite pour effectuer le fonctionnement, le réglage, le nettoyage et l'entretien ordinaire du meuble réfrigéré
- **TECHNICIEN SPÉCIALISÉ** formé et autorisé par l'organisme indiqué dans le contrat (constructeur/concessionnaire/distributeur) à effectuer: l'installation, l'entretien exceptionnel, la réparation, le remplacement et la révision du meuble réfrigéré

Les instructions d'utilisation sont également disponibles sur:
www.eptarefrigeration.com.

En ce qui concerne les réglementations et les certifications du meuble réfrigéré, veuillez faire référence à la déclaration de conformité.

Conservez toujours le livret d'instructions et en cas de vente.

Modello - Modèle - Model Modell - Modelo - Modelo	GRANSESIA	COSTAN eptarefrigeration
Fabbricante - Constructeur - Manufacturer Hersteller - Fabricante - Fabricante	Epta Spa - Via Mecenate, 86 - 20138 Milano (MI) ITALIA Tel. 02/55403211 Telefax 02/55401023	3/20

2. AVERTISSEMENTS DE SÉCURITÉ

2.1 Avertissements généraux

 Le constructeur décline toute responsabilité pour tout préjudice corporel ou matériel dû à un manque d'observation des avertissements contenus dans ce manuel. Toute personne utilisant ce meuble réfrigéré doit impérativement avoir lu le manuel de l'utilisateur.

 L'employeur doit instruire ses personnels sur les risques d'accident, les dispositifs prévus pour la sécurité des personnels, les risques d'émissions sonores et les règles générales de prévention des accidents requises par la réglementation en vigueur.

 Le meuble réfrigéré doit être utilisé par des adultes possédant les connaissances nécessaires et dont les capacités physiques, sensorielles ou mentales ne sont pas diminuées. Le meuble réfrigéré n'est pas destiné à être utilisé par des mineurs (en particulier de 0 à 3 ans). Il est de la responsabilité des adultes de surveiller les enfants afin qu'ils ne jouent pas avec le meuble réfrigéré.

 Tout autre usage non explicitement indiqué dans ce manuel doit être considéré comme dangereux, et le constructeur ne pourra être tenu pour responsable d'éventuels dommages dérivant d'une utilisation impropre, erronée et non raisonnable.

 Le meuble réfrigéré doit être utilisé par des personnels munis des équipements de protection individuelle appropriés.

 Le port de gants de travail est obligatoire.

 Ne pas laisser le meuble réfrigéré exposé aux agents atmosphériques.

 Ne pas utiliser des jets d'eau directs ou indirects sur le meuble réfrigéré.

 Ne pas toucher le meuble réfrigéré avec les mains ou les pieds mouillés ou humides, ne pas utiliser le meuble réfrigéré les pieds nus.

 Le retrait de protections ou de panneaux requérant l'utilisation d'outils doit exclusivement être effectué par des personnels qualifiés.

 Pour le montage d'accessoires dédiés, en option, veuillez vous adresser au service après-vente agréé le plus proche.

 Toute intervention doit exclusivement être effectuée par des personnels qualifiés. Dans tous les cas, avant toute intervention, couper impérativement l'alimentation électrique du meuble.

Modello - Modèle - Model Modell - Modelo - Modelo	GRANSESIA	COSTAN <small>eptarefrigeration</small>
Fabbricante - Constructeur - Manufacturer Hersteller - Fabricante - Fabricante	Epta Spa - Via Mecenate, 86 - 20138 Milano (MI) ITALIA Tel. 02/55403211 Telefax 02/55401023	4/20

IT
FR
EN
DE
ES
PT

 Instruire toute personne utilisant le meuble sur la position de l'interrupteur-sectionneur.

 Le réglage du thermostat est réservé au personnel technique du service après-vente.

 Faire attention aux parties chaudes ou en mouvement marquées du symbole approprié.

 En cas d'incendie, ne pas utiliser de l'eau pour éteindre les flammes, mais exclusivement des extincteurs à sec.

 Ne pas endommager le circuit réfrigérant.

 Éviter les flammes ou les étincelles à l'intérieur de l'appareil.

 Veillez à ce que les fentes d'aération du caisson de l'appareil soient toujours bien dégagées.

 Ne pas utiliser d'appareils électriques à l'intérieur des compartiments de l'appareil pour la conservation des aliments congelés, si ceux-ci ne sont pas du type préconisé par le constructeur.

 Ne pas conserver de substances explosives ou dangereuses, telles que des récipients sous pression contenant du gaz propulseur inflammable, à l'intérieur de cet appareil.

 Ne pas poser de poids sur le toit du meuble réfrigéré; il est opportun d'éviter de placer des aliments non emballés directement sur les plateaux, veuillez utiliser des conteneurs pour aliments appropriés.

 Ne placez pas de contenants de liquide et ne versez pas de liquide sur le comptoir.

2.2 Avertissements pour l'entretien du meuble réfrigéré

 L'accès aux parties électriques et/ou aux parties nécessitant l'utilisation d'outils est réservé aux techniciens spécialisés.

 Avant toute opération d'entretien ou de nettoyage réservée à l'utilisateur, couper la tension au meuble en intervenant sur l'interrupteur-sectionneur général mural.

 Faire attention aux parties chaudes ou en mouvement marquées du symbole approprié.

 Le port de gants de travail est obligatoire.

Modello - Modèle - Model Modell - Modelo - Modelo	GRANSESIA	COSTAN <small>eptarefrigeration</small>
Fabbricante - Constructeur - Manufacturer Hersteller - Fabricante - Fabricante	Epta Spa - Via Mecenate, 86 - 20138 Milano (MI) ITALIA Tel. 02/55403211 Telefax 02/55401023	5/20

2.3 Avertissements électriques



S'assurer que la tension d'alimentation correspond aux caractéristiques de plaque du meuble.



L'installation électrique doit être effectuée dans les règles de l'art par des techniciens spécialisés.



Le retrait du couvercle du tableau électrique est réservé aux techniciens spécialisés.



Conformément aux règles d'installation, le réseau d'alimentation doit comporter un dispositif de déconnexion omnipolaire, assurant la déconnexion complète du secteur dans les conditions de surtension de catégorie III.



L'installation du meuble réfrigéré doit être effectuée conformément aux instructions du constructeur, par des personnels professionnellement qualifiés et dans le respect des normes sur les installations électriques en vigueur dans chaque pays.



Toute installation erronée du meuble réfrigéré risque de causer des préjudices aux personnes, aux animaux ou aux biens par rapport auxquels le constructeur décline toute responsabilité.



Si le cordon d'alimentation est endommagé, il doit être remplacé par du personnel de service autorisé. N'essayez pas de réparer le câble.



Ne pas alimenter le banc s'il est endommagé. En cas de doute, contactez le service après-vente ou votre revendeur.

2.4 Interdictions



Il est interdit d'utiliser des dispositifs autres que ceux fournis par le constructeur dans le meuble réfrigéré, pour accélérer le dégivrage.



Il est interdit aux personnels non spécialisés de retirer le couvercle du tableau électrique ou d'ouvrir des panneaux nécessitant l'utilisation d'outils.



Il est interdit d'utiliser le meuble réfrigéré pour conserver et/ou exposer des substances explosives, inflammables ou corrosives, telles par exemple des bombes aérosol contenant un gaz propulseur inflammable.



Il est interdit d'utiliser le meuble réfrigéré pour conserver et/ou exposer des produits pharmaceutiques.



En cas de produits **NON EMBALLÉS OU CONSERVÉS À BASSE TEMPÉRATURE**, il est interdit d'utiliser le meuble réfrigéré pour conserver et/ou exposer des bouteilles et des emballages en verre.



Il est interdit d'installer le meuble réfrigéré dans un environnement contenant des substances gazeuses explosives.



Il est interdit de retirer la plaque du matricule du meuble réfrigéré.



Il est interdit de monter sur le comptoir ou sur le pare-chocs du comptoir.

IT

FR

EN

DE

ES

PT

Modello - Modèle - Model Modell - Modelo - Modelo	GRANSESIA	COSTAN eptarefrigeration
Fabbricante - Constructeur - Manufacturer Hersteller - Fabricante - Fabricante	Epta Spa - Via Mecenate, 86 - 20138 Milano (MI) ITALIA Tel. 02/55403211 Telefax 02/55401023	6/20

IT
FR
EN
DE
ES
PT

3. DESCRIPTION GÉNÉRALE

3.1 Vues en coupe

COMPACT

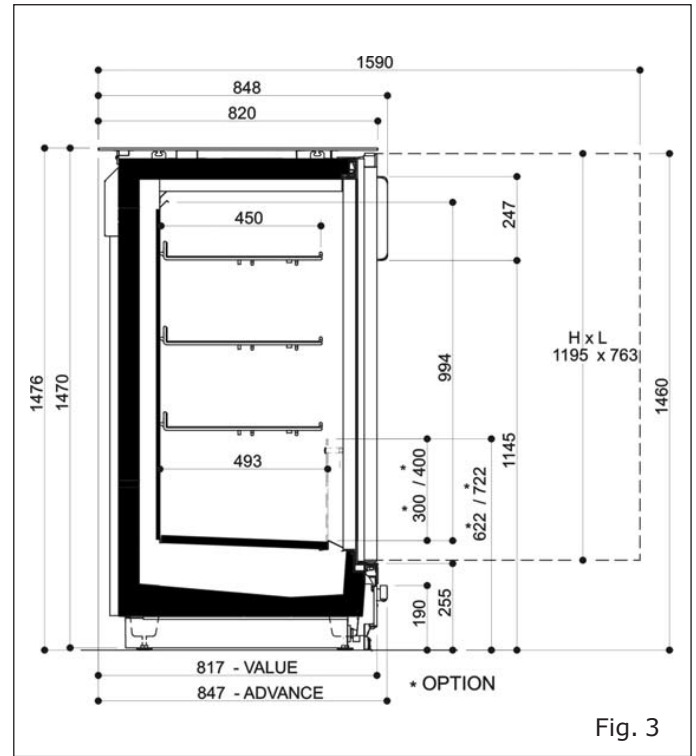

Fig. 3

NARROW

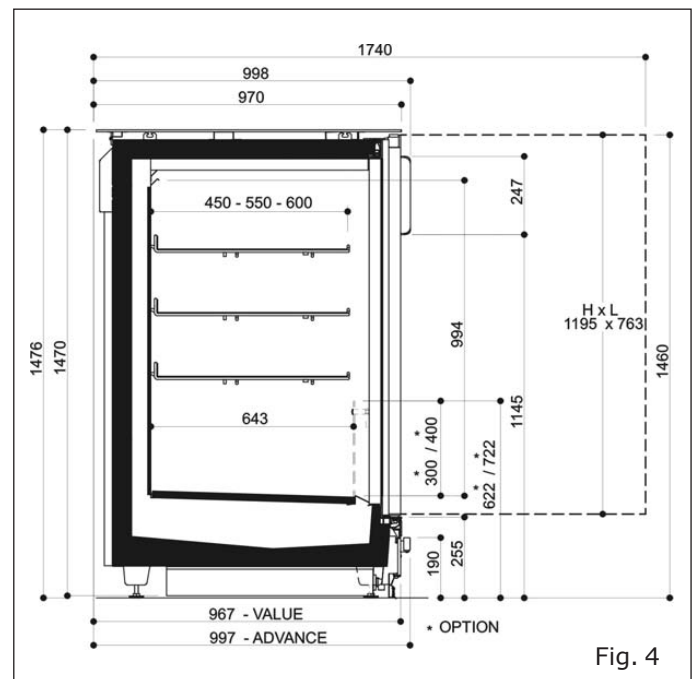

Fig. 4

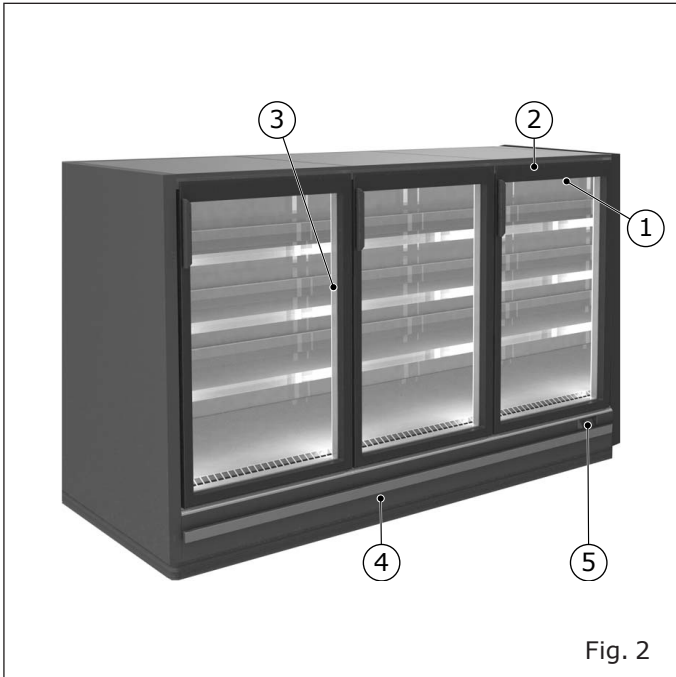

Fig. 2

1. Plaquette des caractéristiques
2. Interrupteur lumières
3. Éclairage
4. Pare-chocs (option)
5. Télé-thermostat

Modello - Modèle - Model Modell - Modelo - Modelo	GRANSESIA	COSTAN eptarefrigeration
Fabbricante - Constructeur - Manufacturer Hersteller - Fabricante - Fabricante	Epta Spa - Via Mecenate, 86 - 20138 Milano (MI) ITALIA Tel. 02/55403211 Telefax 02/55401023	7/20

4. TRANSPORT DU MEUBLE RÉFRIGÉRÉ



1. Points de levage

Tab. I

Modèle		Poids (kg)	Poids avec emballage (kg)
2D	COMPACT	350	490
3D		500	550
2D EOL		350	490
2D	NARROW	350	490
3D		500	550
EOL 3D-S		500	550

Modello - Modèle - Model Modell - Modelo - Modelo	GRANSESIA	COSTAN eptarefrigeration
Fabbricante - Constructeur - Manufacturer Hersteller - Fabricante - Fabricante	Epta Spa - Via Mecenate, 86 - 20138 Milano (MI) ITALIA Tel. 02/55403211 Telefax 02/55401023	8/20

IT
FR
EN
DE
ES
PT

5. CONDITIONS AMBIANTES



Fig. 7



Fig. 9

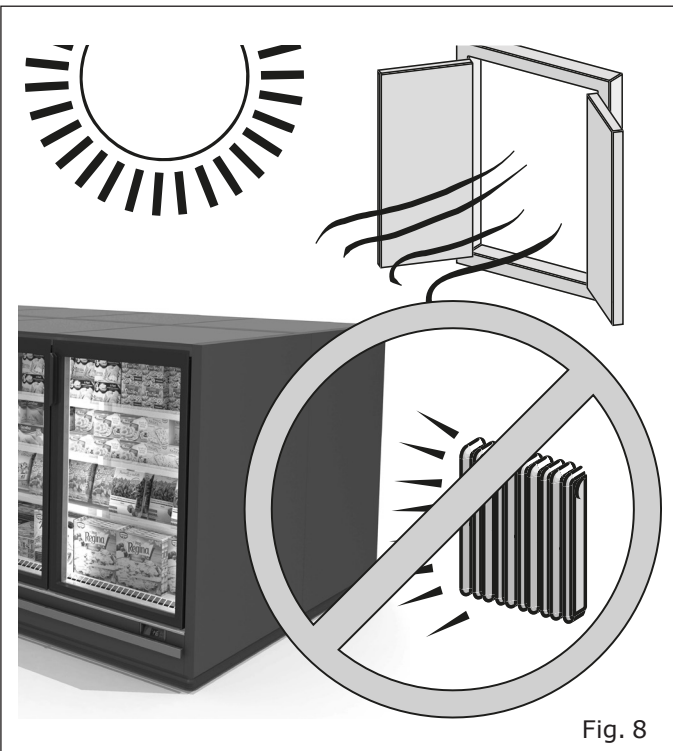

Fig. 8

Tab. II

Caractéristiques	
Type de local	Fermé
Température	25°C
Humidité relative	60 %
Éclairage	600 lx

Modello - Modèle - Model Modell - Modelo - Modelo	GRANSESIA	COSTAN eptarefrigeration
Fabbricante - Constructeur - Manufacturer Hersteller - Fabricante - Fabricante	Epta Spa - Via Mecenate, 86 - 20138 Milano (MI) ITALIA Tel. 02/55403211 Telefax 02/55401023	9/20

6. CARACTÉRISTIQUES TECHNIQUES





 <small>EPTA S.p.A. Via Mecenate, 86 20138 Milano - Italy</small>		12	
1		2	
3		4	
5		6	
7		8	
9		10	
		11	
 <small>Read Operator's Manual available at www.eptarefrigeration.com or calling +39 0437 968379</small>		12	
13		14	
15		16	
17		18	
19		20	
21		22	
23		24	
25			
			

Fig. 10

- | | |
|--|--|
| <ol style="list-style-type: none"> 1. Origine du produit 2. Produit dans le "Pays d'origine" 3. Tension nominale 4. Puissance nominale 5. Fréquence nominale 6. Courant nominal 7. Puissance de dégivrage 8. Courant et dégivrage 9. Système de chauffe 10. Système d'éclairage 11. Manuel de l'opérateur 12. Code-barres 13. Numéro de série | <ol style="list-style-type: none"> 14. Date de fabrication 15. Code Hat 16. Modèle 17. Type de réfrigérant 1 18. Masse réfrigérante 1 19. Type de réfrigérant 2 20. Masse réfrigérante 2 21. Classe climatique 22. Isolation gaz 23. Indice de protection 24. Marques de certification 25. Marque RAEE |
|--|--|





L'utilisation de séparateurs internes entre les étagères et à la base est obligatoire pour assurer le bon fonctionnement du meuble réfrigéré. Pour le version à 3 portes les séparateurs sont fournis de série.

Modello - Modèle - Model Modell - Modelo - Modelo	<h1>GRANSESIA</h1>	
Fabbricante - Constructeur - Manufacturer Hersteller - Fabricante - Fabricante	Epta Spa - Via Mecenate, 86 - 20138 Milano (MI) ITALIA Tel. 02/55403211 Telefax 02/55401023	10/20

IT
FR
EN
DE
ES
PT

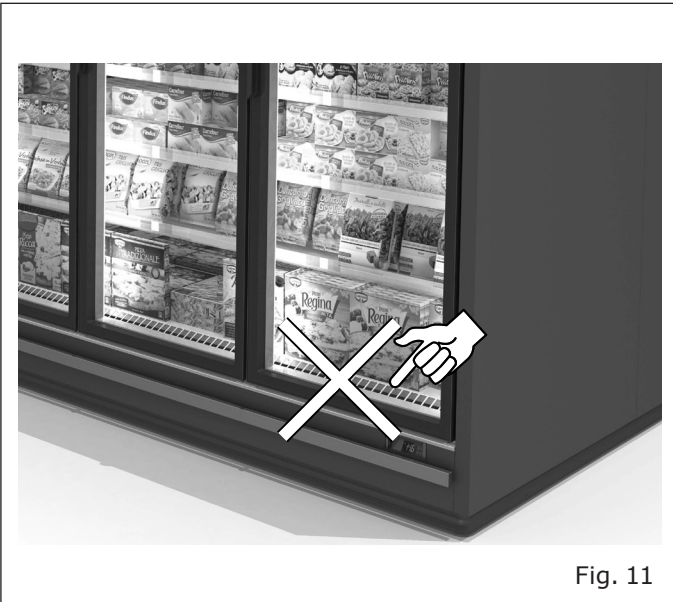
7. UTILISATION DU MEUBLE RÉFRIGÉRÉ



 Ne pas couvrir

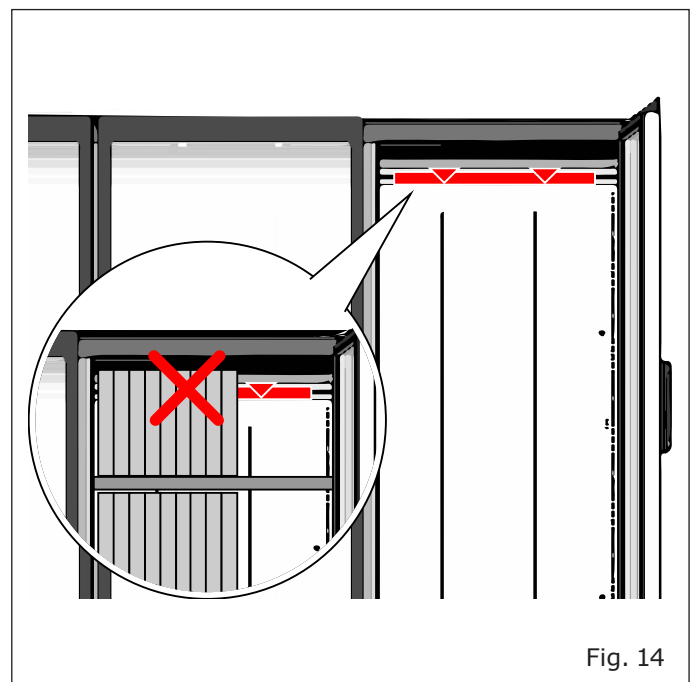
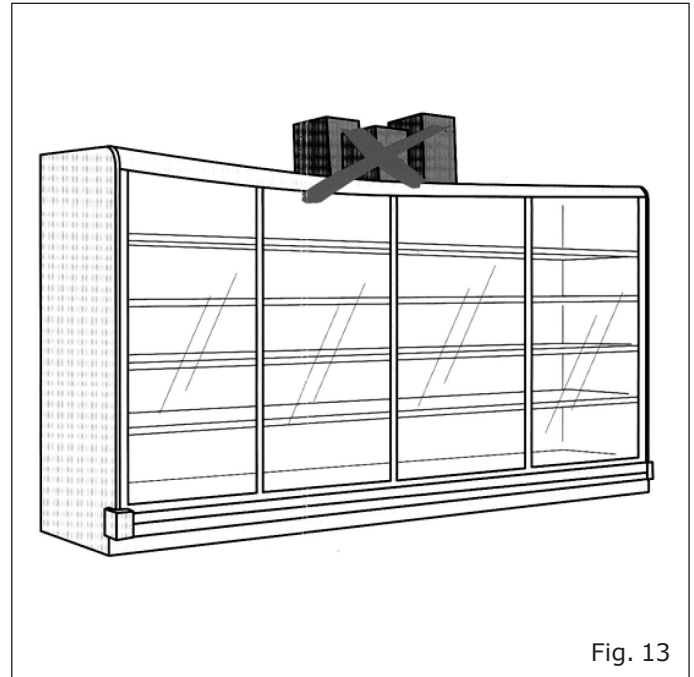

 Respecter la limite de charge

Modello - Modèle - Model Modell - Modelo - Modelo	<h1>GRANSESIA</h1>	
Fabbricante - Constructeur - Manufacturer Hersteller - Fabricante - Fabricante	Epta Spa - Via Mecenate, 86 - 20138 Milano (MI) ITALIA Tel. 02/55403211 Telefax 02/55401023	11/20

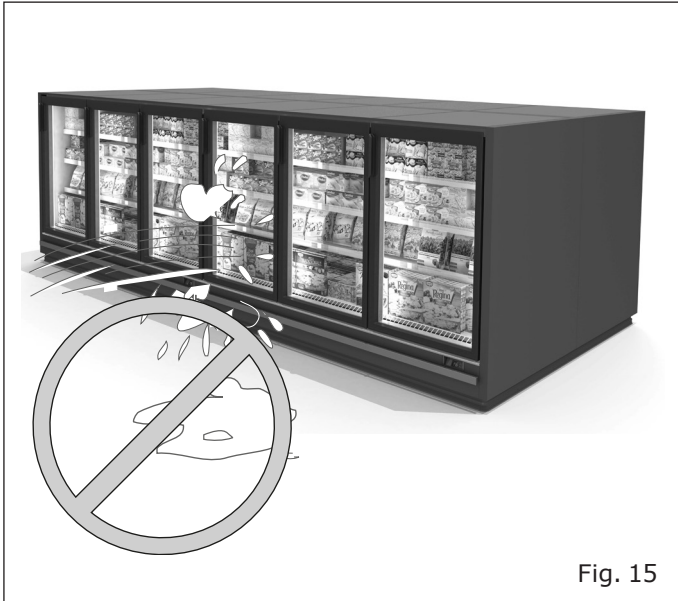

Fig. 15

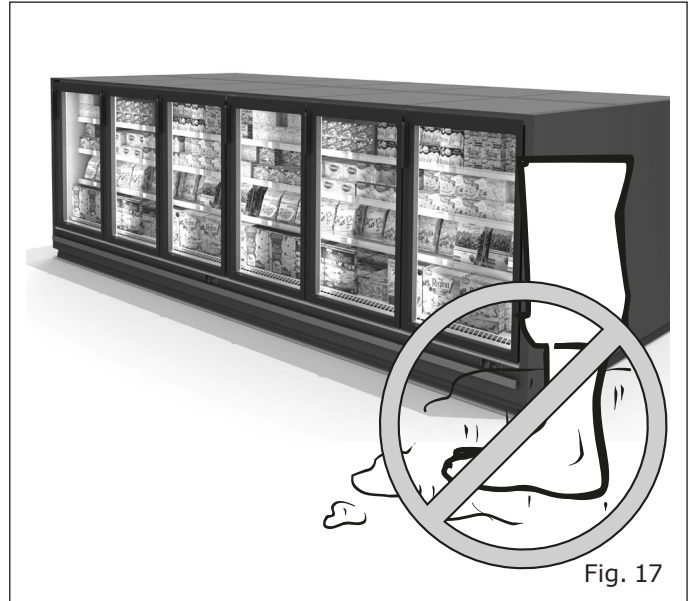

Fig. 17

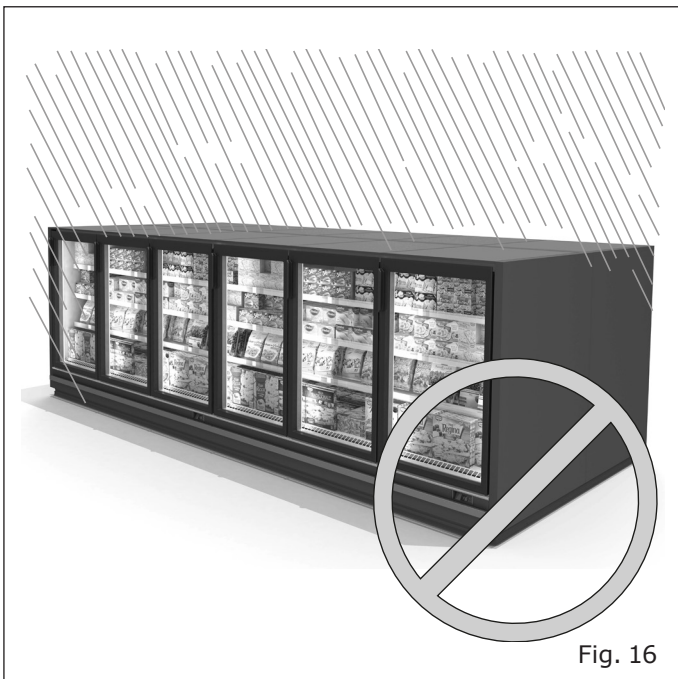

Fig. 16

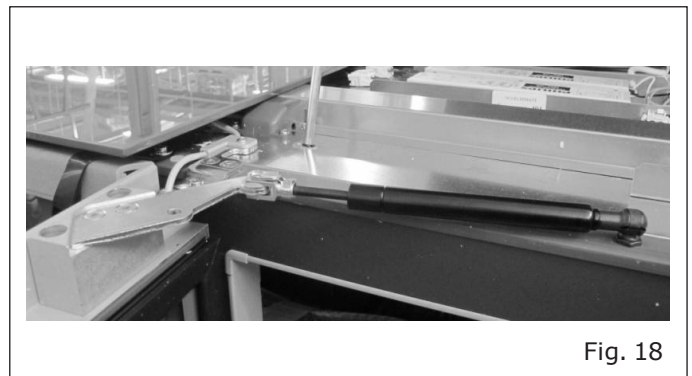

Fig. 18



Fig. 19

- IT
- FR
- EN
- DE
- ES
- PT

Modello - Modèle - Model Modell - Modelo - Modelo	<h1>GRANSESIA</h1>	
Fabbricante - Constructeur - Manufacturer Hersteller - Fabricante - Fabricante	Epta Spa - Via Mecenate, 86 - 20138 Milano (MI) ITALIA Tel. 02/55403211 Telefax 02/55401023	12/20

IT
FR
EN
DE
ES
PT



Fig. 20

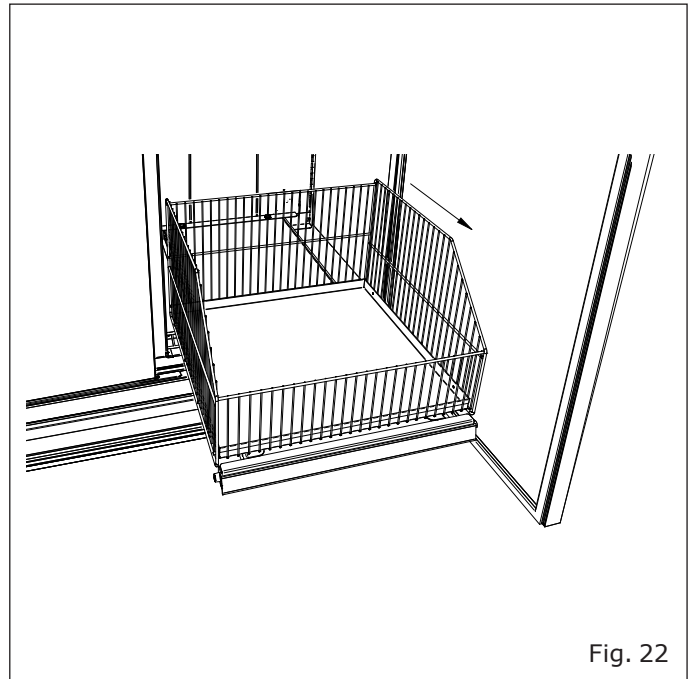

Fig. 22



Fig. 21

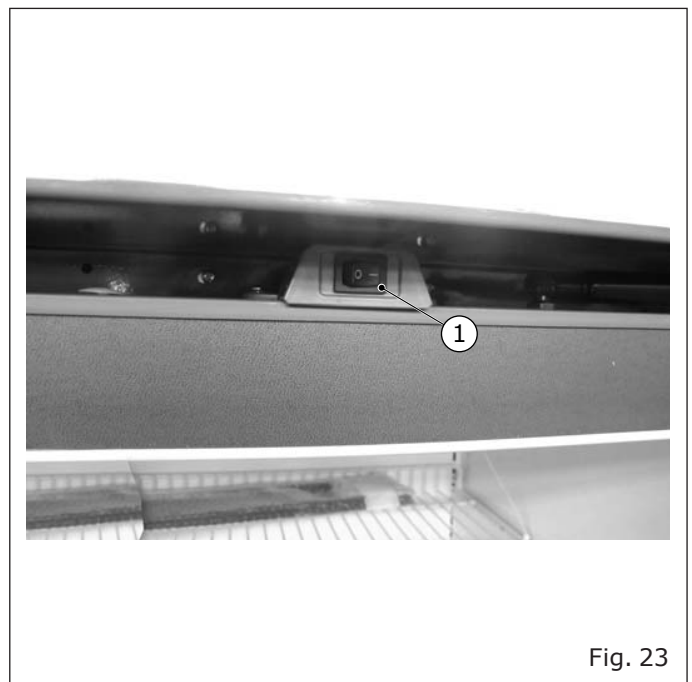

Fig. 23

1. Interrupteur éclairage

Modello - Modèle - Model Modell - Modelo - Modelo	GRANSESIA	COSTAN eptarefrigeration
Fabbricante - Constructeur - Manufacturer Hersteller - Fabricante - Fabricante	Epta Spa - Via Mecenate, 86 - 20138 Milano (MI) ITALIA Tel. 02/55403211 Telefax 02/55401023	13/20

8. ENTRETIEN ORDINAIRE

8.1 Nettoyage du meuble réfrigéré

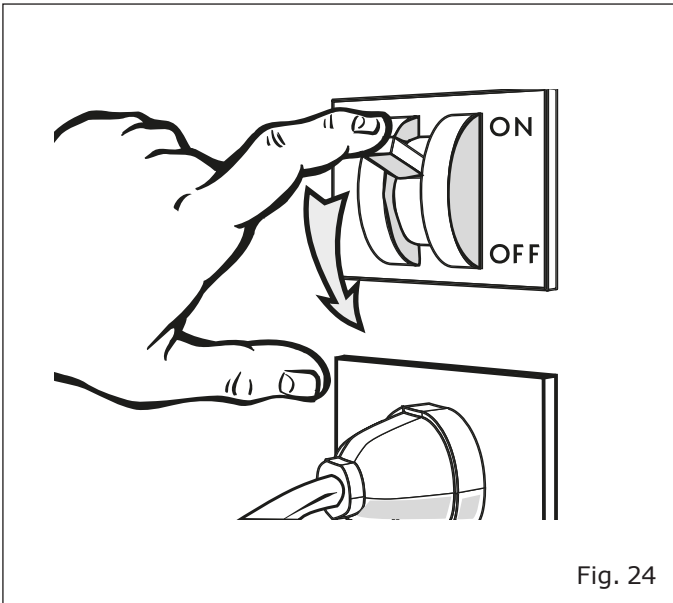

Fig. 24



Fig. 25

Modello - Modèle - Model Modell - Modelo - Modelo	GRANSESIA	COSTAN eptarefrigeration
Fabbricante - Constructeur - Manufacturer Hersteller - Fabricante - Fabricante	Epta Spa - Via Mecenate, 86 - 20138 Milano (MI) ITALIA Tel. 02/55403211 Telefax 02/55401023	14/20

IT

9. INDICATIONS UTILISATEUR

FR

9.1 Descriptions du meuble réfrigéré

Cette ligne de meubles réfrigérés est adaptée pour la conservation et l'exposition de crèmes glacées et de surgelés.

EN

DE

ES

CLASSE DE TEMPÉRATURE (selon EN ISO 23953-2): 3L1.

PT

Les caractéristiques générales et les dimensions sont illustrées dans les figures et les vues en coupe indiquées au chapitre "Description générale" (à la page "7").

Durant le transport, le déplacement, la réception, le stockage, l'installation, le chargement, l'utilisation, le nettoyage, l'entretien et le démantèlement, prêter particulièrement attention au risque de basculement du meuble ("Fig. 26").

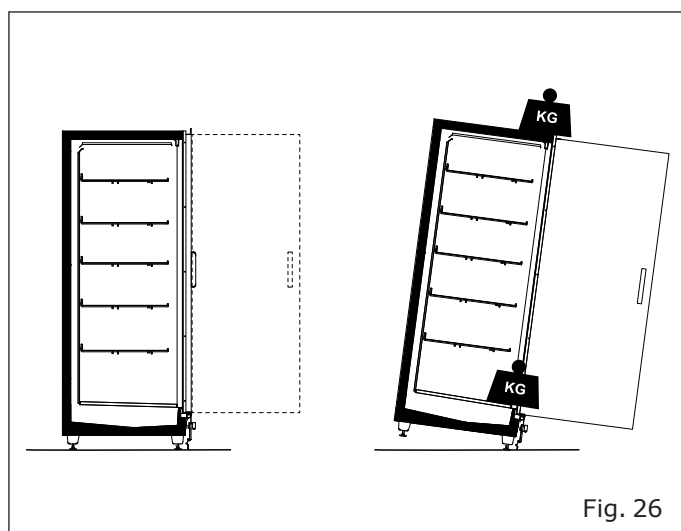

Fig. 26

9.2 Transport et déplacement

Le meuble réfrigéré est contenu dans un emballage spécial muni d'une plateforme pour le déplacement avec des chariots à fourche. Pour le transport et le déplacement du meuble réfrigéré, utiliser:

- exclusivement une plateforme prévue à cet effet ou équivalente
- Un chariot élévateur manuel ou électrique adapté au soulèvement du meuble, présentant des caractéristiques appropriées dans le respect des normes en vigueur

Le poids du meuble réfrigéré (vide et avec emballage) et les dimensions de l'emballage sont indiqués au chapitre "Transport du meuble réfrigéré" (tableau "Tab. I" et figures à la page "8").

Les opérations de déplacement doivent être effectuées par des personnels qualifiés, en mesure d'évaluer les poids, les points de levage et les moyens les plus adaptés, tant en ce qui concerne la sécurité que la portée.

9.3 Réception et stockage

Vérifier l'état de l'emballage avant de prendre livraison du meuble réfrigéré du transporteur.

En cas de dommages évidents à l'emballage:

- Retirer l'emballage du meuble réfrigéré en présence du transporteur.
- Signer sous réserve le bon de livraison.

Le constructeur ne répond pas des dommages éventuellement dus au transport ou à un stockage erroné du meuble réfrigéré.

Conserver le meuble dans un endroit à l'abri du soleil et des intempéries, à une température comprise entre -25°C et +55°C et avec une humidité relative de l'air comprise entre 30% et 95%.

Modello - Modèle - Model Modell - Modelo - Modelo	GRANSESIA	
Fabbricante - Constructeur - Manufacturer Hersteller - Fabricante - Fabricante	Epta Spa - Via Mecenate, 86 - 20138 Milano (MI) ITALIA Tel. 02/55403211 Telefax 02/55401023	15/20

9.4 Installation et conditions ambiantes

Ce meuble réfrigéré n'est pas conçu pour être installé à l'extérieur.

Pour que le meuble fonctionne correctement, vérifier qu'il est mis en place:

- Sur un sol nivelé ("Fig. 7").
- Loin de toute source de chaleur, rayons directs du soleil, portes, fenêtres, ventilateurs et bouches d'aération ("Fig. 8").

Assurer l'espace nécessaire à l'utilisation du meuble réfrigéré par la clientèle.

Les conditions du lieu où installer le meuble sont indiquées dans "Conditions ambiantes".

9.5 Connexion électrique

Installer un interrupteur-sectionneur omnipolaire en amont du meuble réfrigéré. L'interrupteur-sectionneur doit avoir:

- Écart minimum entre les contacts 3 mm.
- Pouvoir d'interruption adapté

L'interrupteur-sectionneur doit être mis en place dans une position permettant d'être actionné aisément dans des situations d'urgence (distance maximum de 3 m).

Avant de brancher le meuble réfrigéré, s'assurer que la tension d'alimentation correspond aux caractéristiques de plaque du meuble. Pour garantir un fonctionnement régulier, la variation de tension maximale doit être comprise entre +/- 6% de la valeur nominale.

9.6 Caractéristiques techniques

La plaque matricule contient les caractéristiques techniques du meuble réfrigéré. Sa position et les caractéristiques sont indiquées dans "Caractéristiques techniques" ("Fig. 10").

Les schémas électriques, les listes d'étalonnage des instruments de contrôle, les instructions d'installation et une copie de la Déclaration de Conformité sont disponibles sur le site <https://documents.eptarefrigeration.com>.

Le niveau de pression sonore générée par le fonctionnement du meuble est inférieur à 70 dB(A). Le meuble réfrigéré ne produit pas de vibrations nuisibles.

9.7 Chargement du produit

Mettre le meuble sous tension pour démarrer son cycle de refroidissement, en intervenant sur l'interrupteur-sectionneur général mural. Après environ 2 heures vous pouvez charger la marchandise dans le meuble réfrigéré.

Le meuble réfrigéré est en mesure de maintenir la température de la marchandise, mais non de l'abattre. Les denrées alimentaires ne doivent donc être placées à l'intérieur du meuble que si elles ont déjà été refroidies à leur température de conservation respective. Ne jamais placer de produits chauds dans le meuble réfrigéré.

En présence d'un meuble avec vitres frontales, il est conseillé d'effectuer son nettoyage lorsque les clients ne se trouvent pas dans l'espace de vente.

Lors du stockage de la marchandise, s'assurer que:

- le chargement est homogène par ses dimensions et la qualité de la marchandise
- La marchandise ne bouche pas le flux d'air réfrigéré ("Fig. 11").
- La marchandise ne dépasse pas la limite de charge ("Fig. 14").

Charge maximale admissible uniformément distribuée:

- Sur les étagères: 160 kg/m²
- Sur le plateau de base: 225 kg/m²

Modello - Modèle - Model Modell - Modelo - Modelo	GRANSESIA	COSTAN <small>eptarefrigeration</small>
Fabbricante - Constructeur - Manufacturer Hersteller - Fabricante - Fabricante	Epta Spa - Via Mecenate, 86 - 20138 Milano (MI) ITALIA Tel. 02/55403211 Telefax 02/55401023	16/20

IT
FR
EN
DE
ES
PT



La porte est conçue pour rester ouverte **SANS AUCUN SYSTÈME DE BLOCAGE MÉCANIQUE**, simplement en l'ouvrant de 90°. En outre, le système de fermeture "soft-closing" assure une fermeture automatique lente et douce dans sa partie finale, sans besoin de forcer la fermeture. Il n'est donc **PAS NÉCESSAIRE** d'OUVRIRE la porte au-delà de 90°, ni de la bloquer avec des poids ou de la **MAINTENIR** en position si elle est déjà ouverte à 90° ("Fig. 19, "Fig. 21").



Durant le chargement, en présence de paniers coulissants (en option), veillez de ne pas les extraire tous en même temps ("Fig. 22").

9.8 Utilisation du meuble réfrigéré

Éclairage

L'éclairage du meuble réfrigéré est commandé par un interrupteur situé sur le meuble en haut à droite.

Thermostat/thermomètre

Un thermostat/thermomètre à distance est placé sur le meuble en bas à droite pour le contrôle de la température.

9.9 Nettoyage et entretien ordinaire

Il est recommandé d'assurer une bonne visibilité dans la zone d'intervention, éventuellement en utilisant une source d'éclairage supplémentaire.



Revêtement anti-buée sur les portes à **BASSE CONSOMMATION**. Les portes du meuble réfrigéré présentent un revêtement anti-buée qui prévient la formation de buée dans n'importe quelle condition de température et d'humidité, même après une immersion prolongée dans l'eau ou des nettoyages fréquents. Extrêmement hydrophile, le revêtement produit des gouttelettes d'eau qui se propagent et ne se transforment donc pas en buée. Bien que le revêtement absorbe l'humidité, il ne se dissout pas dans l'eau et ne se tache donc pas lorsqu'il est mouillé. Le film n'est pas endommagé par les nettoyants pour vitres du commerce, les détachants, l'ammoniaque, l'alcool et l'essence et il ne se décolore pas lorsqu'il est exposé au soleil ou à la chaleur.

Les portes sont fournies avec un revêtement anti-buée laminé sur la vitre intérieure et sont protégées par un layer.

Le layer de protection est partiellement relevé sur les côtés pour faciliter son retrait lors de l'utilisation. Le retrait du layer de protection doit avoir lieu après l'installation des portes sur le meuble réfrigéré une fois que celui-ci aura atteint la température d'utilisation, pour permettre le fonctionnement immédiat du film anti-buée.

Pour rappeler ce passage, sur la pellicule de protection est apposée l'étiquette suivante: "DO NOT REMOVE THE PROTECTIVE FILM UNTIL THE CABINET HAS REACHED THE OPERATING TEMPERATURE".

Modello - Modèle - Model Modell - Modelo - Modelo	GRANSESIA	COSTAN eptarefrigeration
Fabbricante - Constructeur - Manufacturer Hersteller - Fabricante - Fabricante	Epta Spa - Via Mecenate, 86 - 20138 Milano (MI) ITALIA Tel. 02/55403211 Telefax 02/55401023	17/20

Nettoyage du meuble réfrigéré

Utiliser exclusivement de l'eau à la température maximum de 65°C et du savon ou un produit détergent ménager neutre dilué dans l'eau. Pour les surfaces vitrées, utilisez uniquement des produits de nettoyage pour vitres. Il est conseillé d'éviter d'utiliser de l'eau, car elle risquerait de déposer du calcaire sur la surface du verre.

Veillez absolument de ne pas utiliser:

- d'éponges abrasives
- de produits inflammables ou abrasifs tels que l'alcool, l'acétone ou les solvants
- des détergents contenant des tensioactifs non ioniques, du citron ou du vinaigre (acide acétique)



Ne pas laver ou nettoyer la partie supérieure du meuble avec de l'eau ou des liquides.

Nettoyer **UNE FOIS PAR SEMAINE** toutes les parties extérieures du meuble.

Nettoyer **UNE FOIS PAR MOIS** toutes les parties intérieures du meuble, en suivant les instructions indiquées ci-dessous:

- Couper la tension électrique au meuble réfrigéré en intervenant sur l'interrupteur-sectionneur général mural ("Fig. 24").
- Vider le meuble réfrigéré en stockant la marchandise en chambre froide ou dans des réfrigérateurs aptes à maintenir leur température de conservation.
- Attendre que l'intérieur du meuble réfrigéré soit à la température ambiante avant de commencer le nettoyage
- Après avoir vérifié attentivement que l'intérieur du meuble est complètement sec, remettre en fonction l'appareil en le mettant sous tension.
- Attendre environ deux heures avant de charger la marchandise.

Pour mettre le meuble hors service, débrancher l'alimentation et suivre la marche indiquée ci-dessus, en laissant les portes ouvertes (si disponible) pour éviter les odeurs désagréables.

TOUS LES TROIS MOIS effectuer le dégivrage du meuble afin d'éliminer la glace qui s'est éventuellement formée sur les ailettes de l'évaporateur en empêchant son bon fonctionnement. La durée et le nombre de dégivrages sont directement réglés d'origine. D'autres réglages éventuels sont exclusivement réservés au service après-vente. L'eau de dégivrage est collectée dans une évacuation spéciale. Vérifier périodiquement que l'eau de dégivrage s'écoule normalement. Si cela n'est pas, utilisez une sonde flexible et non pointue.

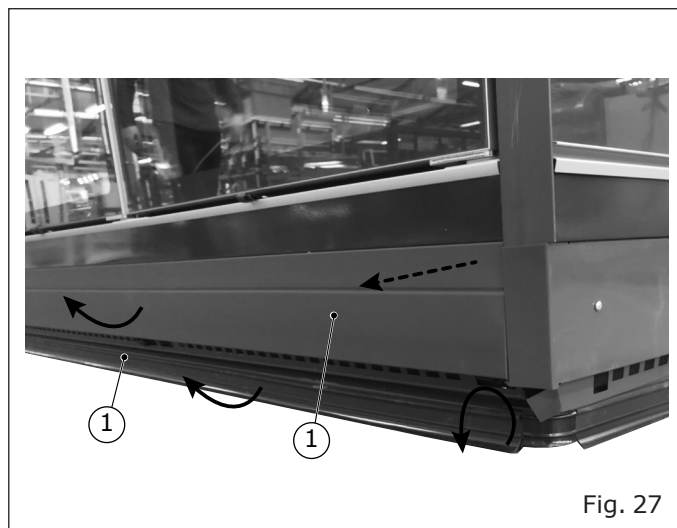

Fig. 27

1. Retirer

Intervenir de la manière indiquée pour le nettoyage **MENSUEL** des parties intérieures, mais dans ce cas il faudra prévoir un délai d'attente plus long afin que la glace fonde complètement.

IT

FR

EN

DE

ES

PT

Modello - Modèle - Model Modell - Modelo - Modelo	GRANSESIA	COSTAN eptarefrigeration
Fabbricante - Constructeur - Manufacturer Hersteller - Fabricante - Fabricante	Epta Spa - Via Mecenate, 86 - 20138 Milano (MI) ITALIA Tel. 02/55403211 Telefax 02/55401023	18/20

IT 9.10 Situations d'urgence

FR Le meuble réfrigéré ne démarre pas ou s'arrête:

- EN • Vérifier l'absence de blackout électrique.
- DE • Vérifier que l'interrupteur général mural est branché.
- ES • Vérifier que la fiche du meuble réfrigéré est branchée dans la prise secteur.

PT Si la coupure électrique n'est pas due à ces raisons, contactez le service après-vente agréé le plus proche, retirez complètement tous les produits et stockez-les immédiatement en chambre froide ou dans des réfrigérateurs aptes à maintenir la température de conservation.

Le meuble réfrigéré ne refroidit pas suffisamment:

- S'assurer que le meuble est chargé correctement.
- Dégivrer le meuble et reprendre ensuite son fonctionnement normal, si cette opération n'a pas été effectuée depuis plus de trois mois.
- Vérifier que le meuble réfrigéré n'est pas placé près de sources de chaleur ou de courants d'air.
- Vérifier les conditions ambiantes indiquées au chapitre "Conditions ambiantes" ("Tab. II").
- Vérifier la planéité du meuble réfrigéré à l'aide d'un niveau.

Si le meuble ne refroidit toujours pas, contactez le service après-vente agréé le plus proche.

Le meuble réfrigéré est bruyant:

- Vérifier que les vis et les boulons sont parfaitement serrés.
- Vérifier la planéité du meuble réfrigéré à l'aide d'un niveau.

Si l'inconvénient persiste, contactez le service après-vente agréé le plus proche.

9.11 Service après-vente

En cas de nécessité d'intervention de techniciens, contactez immédiatement le fournisseur chez qui vous avez acheté le meuble réfrigéré.

En cas de nécessité d'utiliser des pièces de rechange, toujours contacter le service après-vente: demandez et assurez-vous que les pièces de rechange fournies sont d'origine.

9.12 Démantèlement et élimination

Conformément aux normes en matière d'élimination des déchets en vigueur dans les différents pays et pour le respect de l'environnement où nous vivons, veuillez trier les parties du meuble réfrigéré de manière à pouvoir les éliminer séparément ou éventuellement, les récupérer.

Toutes les parties qui composent le meuble réfrigéré ne sont pas assimilables à des déchets solides urbains, exception faite des parties métalliques qui ne figurent pas parmi les déchets spéciaux dans la plupart des pays européens.



Le système de réfrigération est à haute pression. Contactez le personnel expérimenté avant toute mise au rebut.

Ne jamais couper ou séparer les composants du circuit de réfrigération avant d'avoir vidangé le circuit et avoir fait récupérer le réfrigérant par des personnels qualifiés.

Modello - Modèle - Model Modell - Modelo - Modelo	GRANSESIA	COSTAN eptarefrigeration
Fabbricante - Constructeur - Manufacturer Hersteller - Fabricante - Fabricante	Epta Spa - Via Mecenate, 86 - 20138 Milano (MI) ITALIA Tel. 02/55403211 Telefax 02/55401023	19/20

10. AVERTISSEMENTS GÉNÉRAUX SUPPLÉMENTAIRES

Instructions pour une installation et un entretien corrects

Les instructions d'utilisation et d'entretien sont indiquées dans le manuel de l'utilisateur disponible dans notre site web:
www.eptarefrigeration.com.

Des instructions d'installation pour le personnel expérimenté sont disponibles:

- Après de notre réseau après-vente
- Dans certaines catégories de produits, sous forme papier, livrées avec le produit.

Services professionnels de réparation.

Les services sont fournis par notre réseau après-vente qui peut être consulté dans l'espace Contacts à l'adresse web www.eptarefrigeration.com.

Pièces de rechange

Les pièces de rechange et les informations pour la réparation de l'appareil sont disponibles pendant au moins 8 ans après la mise hors production du produit à l'adresse web [suivant \[www.epta-service.com/service\]\(http://www.epta-service.com/service\)](http://www.epta-service.com/service).

Les identifiants d'accès sont fournis en adressant une demande par e-mail à:
servicesupport@eptarefrigeration.com.

Nettoyage du condenseur à air

Les appareils à groupe logé avec condensation à air ne conservent leur efficacité que si le nettoyage du condenseur est effectué de la manière et aux périodicités indiquées dans le manuel d'utilisation et d'entretien.

Informations importantes sur les gaspillages alimentaires

Il est recommandé de suivre attentivement les instructions de conservation figurant sur l'emballage des produits, ainsi que les indications fournies par les producteurs de produits alimentaires.

Par conséquent, les paramétrages de la température doivent être adaptés aux caractéristiques de conservation des produits alimentaires, conformément aux indications contenues dans notre documentation technique. Toute utilisation incorrecte peut entraîner une détérioration.

Conditions ambiantes

Cet appareil est destiné à fonctionner dans des environnements où la température et l'humidité se situent dans les limites indiquées dans le manuel d'utilisation.

Instructions pour le désassemblage

Pour le désassemblage, veuillez vous adresser à des opérateurs professionnels.

Portant depuis toujours une attention particulière à l'environnement, le Groupe Epta met à la disposition des utilisateurs des manuels de démantèlement et de traitement des déchets des meubles réfrigérés à groupe logé, téléchargeables ci-dessous.

- Manuel de démantèlement des meubles réfrigérés à groupe logé ouverts:



- Manuel de démantèlement des meubles réfrigérés à groupe logé fermés:



Autres informations

Pour plus d'informations, veuillez faire référence à www.eptarefrigeration.com et à EPREL en scannant le code QR ci-contre ou sur l'étiquette énergie du produit.



Modello - Modèle - Model Modell - Modelo - Modelo	GRANSESIA	COSTAN <small>eptarefrigeration</small>
Fabbricante - Constructeur - Manufacturer Hersteller - Fabricante - Fabricante	Epta Spa - Via Mecenate, 86 - 20138 Milano (MI) ITALIA Tel. 02/55403211 Telefax 02/55401023	20/20

IT

Limites d'application

FR



Ce meuble réfrigéré a été conçu pour l'utilisation, le transport et le stockage jusqu'à une altitude maximum de 2000 m au-dessus du niveau de la mer.

EN

DE

ES

PT

Stockage:

- Température comprise entre 15°C et 50°C.
- Humidité relative comprise entre 20% et 90%.
- Temps maximum 6 mois.

Transport:

- Température comprise entre 20°C et 70°C.
- Humidité relative comprise entre 20% et 90%.
- Temps maximum 2 mois.

Installation:

- Température comprise entre 0°C et 40°C.
- Humidité relative comprise entre 20% et 90%.
- Temps maximum 2 mois.

Utilisation:

Les performances du meuble réfrigéré ne sont pas garanties hors de son utilisation normale. Son intégrité et la sécurité sont garanties dans les limites ci-après pour des conditions temporaires.

Environnement à l'extérieur du meuble réfrigéré:

- De la classe 1 (16°C / 80%rh) à la classe 4 (30°C / 55%rh) ou à la classe 6 (27°C / 70%rh).

Environnement à l'intérieur du meuble réfrigéré (conditions pour la sécurité électrique):

Meuble réfrigéré à température positive

- Température comprise entre -10°C et +10°C.
- Humidité relative comprise entre 70% et 100%.
- Temps maximum 10 ans.

Meuble réfrigéré à température négative

- Température comprise entre -40°C et 15°C.
- Humidité relative comprise entre 90% et 100%.
- Temps maximum 10 ans.



Durant le fonctionnement des résistances, il pourrait y avoir localement des températures supérieures aux limites ci-dessus, celles-ci demeurent en tout cas dans le respect des conditions de sécurité.

Modello - Modèle - Model Modell - Modelo - Modelo	GRANSESIA	COSTAN <small>eptarefrigeration</small>
Fabbricante - Constructeur - Manufacturer Hersteller - Fabricante - Fabricante	Epta Spa - Via Mecenate, 86 - 20138 Milano (MI) ITALIA Tel. 02/55403211 Telefax 02/55401023	1/20

CONTENT

1. Introduction	2	IT
2. Safety warnings	3	FR
2.1 General warnings	3	EN
2.2 Warnings for cabinet maintenance	4	DE
2.3 Electrical warnings	5	ES
2.4 Prohibitions	5	PT
3. General description	6	
3.1 Sections	6	
4. Transportation of the cabinet	7	
5. Ambient conditions	8	
6. Technical features	9	
7. Use of cabinet	10	
8. Ordinary maintenance	13	
8.1 Cleaning the cabinet	13	
9. User indications	14	
9.1 Description of the cabinet	14	
9.2 Transport and handling	14	
9.3 Receipt and storage	14	
9.4 Installation and ambient conditions	15	
9.5 Electrical connection	15	
9.6 Technical features	15	
9.7 Loading the product	15	
9.8 Use of cabinet	16	
9.9 Cleaning and ordinary maintenance	16	
9.10 Emergency situations	18	
9.11 Technical assistance	18	
9.12 Dismantling and elimination	18	
10. Supplementary general warnings	19	

SYMBOLS USED



Prohibition symbol: it prohibits the carrying out of specific operations.



Attention symbol: accident prevention rules for the operator.



Warning symbol: there is the possibility of damaging the cabinet and/or its components.



Note symbol: it provides useful information.

Modello - Modèle - Model Modell - Modelo - Modelo	GRANSESIA	COSTAN eptarefrigeration
Fabbricante - Constructeur - Manufacturer Hersteller - Fabricante - Fabricante	Epta Spa - Via Mecenate, 86 - 20138 Milano (MI) ITALIA Tel. 02/55403211 Telefax 02/55401023	2/20

IT

1. INTRODUCTION

FR

It is recommended to attentively read the content of this Manual and keep it together with the cabinet.

EN

The manufacturer shall not be held liable for any harm caused to people or damage to property due to the failure to observe the warnings contained in this Manual.

DE

ES

PT



The Manual contains information considered necessary for the good use and operation of the cabinet.

Inside you will find the following descriptions and information:

- a functional description of the cabinet and each of its parts
- information on the safety of the cabinet and the safety rules to follow
- a correct use of the cabinet
- a correct ordinary and programmed maintenance, including cleaning operations

Information not contained in this Manual:

- Installation instructions

For the correct installation of the cabinet refer to the following documents:

- Technical Manual
- Quick Reference Instructions

This Manual is for the following professional figures:

- **QUALIFIED OPERATOR:** a qualified person, educated to operate, regulate, clean and carry out ordinary maintenance on the cabinet
- **SPECIALISED TECHNICIAN** a technician trained and authorised by the body indicated in the contract (manufacturer/concessionaire/distributor) to carry out: installation, non-routine maintenance, repair, replacement and overhaul of the cabinet

The user instructions are also available on: www.eptarefrigeration.com.

Make reference to the declaration of conformity for the regulations and certifications of the cabinet.

Always keep the instruction booklet and in case of sale.

Modello - Modèle - Model Modell - Modelo - Modelo	GRANSESIA	COSTAN eptarefrigeration
Fabbricante - Constructeur - Manufacturer Hersteller - Fabricante - Fabricante	Epta Spa - Via Mecenate, 86 - 20138 Milano (MI) ITALIA Tel. 02/55403211 Telefax 02/55401023	3/20

2. SAFETY WARNINGS

2.1 General warnings



The manufacturer disclaims any liability for damage caused to people or property due to the failure to observe the warnings contained in this manual. Any person who uses this cabinet must read this user manual.



The employer must educate staff on the risks of accidents, on the devices arranged for staff safety, on the risks of noise emission and on the general safety rules provided for by the rules in force.



The cabinet must be used by adults in possession of the necessary knowledge and whose physical, sensory or mental abilities are not impaired; the cabinet is not designed for use by minors (in particular from 0 to 3 years). Children, under the supervision and responsibility of adults, must not play with the cabinet.



Any other use not explicitly indicated in this manual is considered dangerous and the manufacturer cannot be held liable for any damage deriving from improper, wrong and unreasonable use.



The cabinet must be used by staff equipped with the appropriate personal protection equipment.



It is compulsory to use work gloves.



Do not leave the cabinet exposed to weathering agents



Do not use direct or indirect jets of water on the cabinet.



Do not touch the bench with wet or damp hands and feet; do not use the cabinet with naked feet.



The removal of protection devices or panels that require the use of tools to be removed is reserved exclusively for qualified personnel.



For assembling dedicated optional accessories, contact your nearest authorised service centre.



Each intervention must be carried out exclusively by qualified personnel and, in every case, before each intervention the power supply of the cabinet must be disconnected.

IT

FR

EN

DE

ES

PT

Modello - Modèle - Model Modell - Modelo - Modelo	GRANSESIA	COSTAN eptarefrigeration
Fabbricante - Constructeur - Manufacturer Hersteller - Fabricante - Fabricante	Epta Spa - Via Mecenate, 86 - 20138 Milano (MI) ITALIA Tel. 02/55403211 Telefax 02/55401023	4/20

IT
FR
EN
DE
ES
PT

 Instruct anyone who uses the cabinet on the position of the disconnecter switch.

 Thermostat adjustment is reserved for the technical after-sales service only.

 Pay attention to the hot or moving parts marked with the appropriate symbol.

 In case of fire, do not use water to put out the flames but only dry fire extinguishers

 Do not damage the refrigeration circuit.

 Avoid fire or sparks inside the appliance.

 Keep the ventilation openings in the appliance housing free from obstructions.

 Do not use electrical appliances inside the compartments of the appliance for the preservation of frozen foods if these are not the type recommended by the manufacturer.

 Do not store explosive or dangerous substances, such as containers under pressure with flammable propellant, in this appliance.

 Do not leave weights on top of the cabinet roof Resting unpacked products directly on the shelves should be avoided, use suitable food containers.

 Do not place liquid containers and do not pour liquids on the counter.

2.2 Warnings for cabinet maintenance

 Access to the electrical parts and/or parts that require the use of tools is reserved for specialist technicians.

 Prior to any maintenance and cleaning operation reserved for the user, de-energise the cabinet using the wall-mounted disconnecter switch.

 Pay attention to the hot or moving parts marked with the appropriate symbol.

 It is compulsory to use work gloves.

Modello - Modèle - Model Modell - Modelo - Modelo	GRANSESIA	COSTAN <small>eptarefrigeration</small>
Fabbricante - Constructeur - Manufacturer Hersteller - Fabricante - Fabricante	Epta Spa - Via Mecenate, 86 - 20138 Milano (MI) ITALIA Tel. 02/55403211 Telefax 02/55401023	5/20

2.3 Electrical warnings



Ensure that the power voltage corresponds to the rating plate of the cabinet.



The electrical installation must be carried out in a competent manner by specialised technicians.



The removal of the cover of the electrical panel is reserved for specialist technicians.



In compliance with the installation rules, the power supply must include an omnipolar disconnection device, which ensures complete disconnection from the network in overvoltage category III conditions.



The cabinet must be installed following the instructions of the manufacturer, by professionally qualified staff and in compliance with the rules on electrical systems in force in individual Countries.



A wrong cabinet installation can cause damage to people, animals or property, for which the manufacturer cannot be held liable.



If the power cord is damaged, it must be replaced by authorized service personnel. Do not attempt to repair the cable.



Do not power the bench if it is damaged. If in doubt, contact the after-sales service or your dealer.

2.4 Prohibitions



It is forbidden to use devices in addition to those provided in the cabinet by the manufacturer to accelerate the defrosting process.



It is forbidden for unskilled staff to remove the cover of the electrical panel or open panels that require the use of tools.



It is forbidden to use the cabinet for the preservation and/or display of explosive, flammable or corrosive substances, such as spray cans containing a flammable propellant.



It is forbidden to use the cabinet for the preservation and/or display of pharmaceutical products.



In case of PRODUCTS NOT PACKAGED OR PRESERVED AT LOW TEMPERATURE, it is prohibited to use the cabinet for the preservation and/or display of bottles and packages in glass.



It is forbidden to place the cabinet in areas with the presence of explosive gaseous substances.



It is forbidden to remove the identification plate from the cabinet.



It is forbidden to get on the counter or on the counter bumper.

IT

FR

EN

DE

ES

PT

Modello - Modèle - Model Modell - Modelo - Modelo	GRANSESIA	COSTAN eptarefrigeration
Fabbricante - Constructeur - Manufacturer Hersteller - Fabricante - Fabricante	Epta Spa - Via Mecenate, 86 - 20138 Milano (MI) ITALIA Tel. 02/55403211 Telefax 02/55401023	6/20

3. GENERAL DESCRIPTION

3.1 Sections

COMPACT

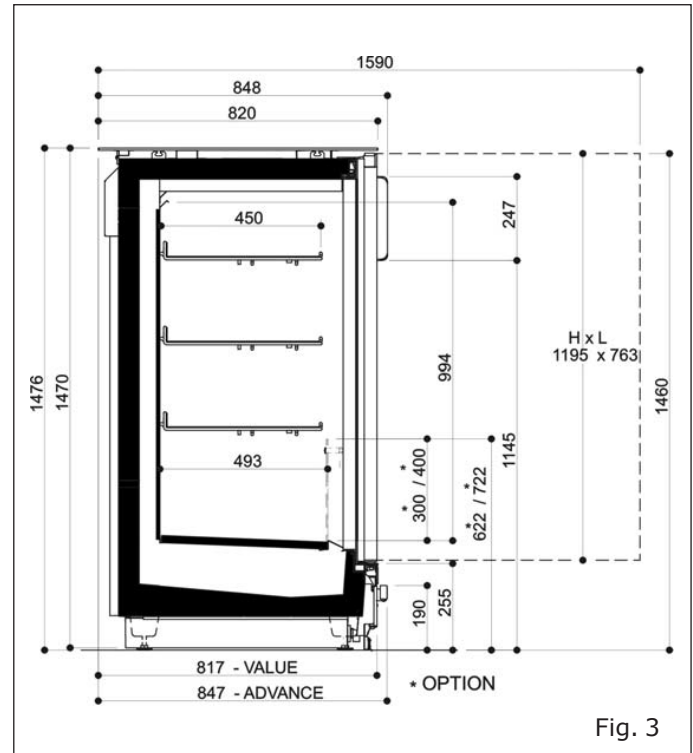

NARROW

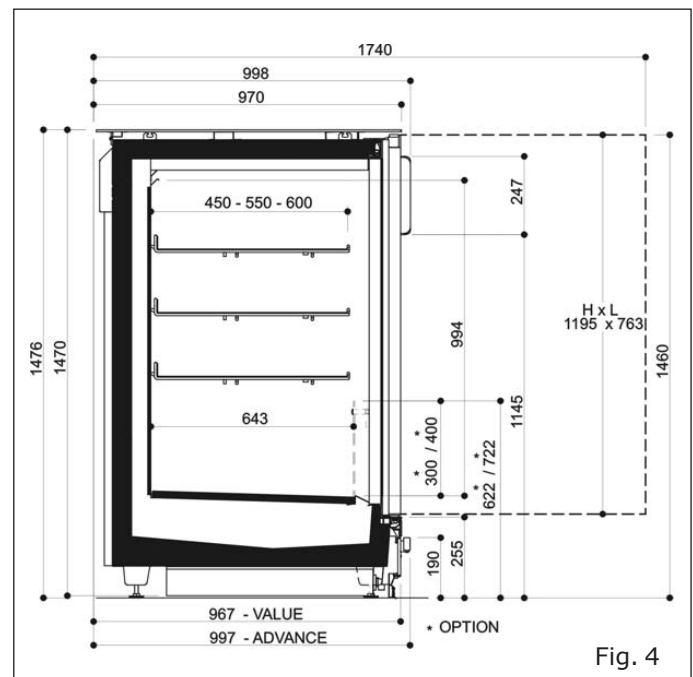

1. Rating plate
2. Light switch
3. Lighting
4. Bumper rail (optional)
5. Remote thermostat

Modello - Modèle - Model Modell - Modelo - Modelo	GRANSESIA	COSTAN eptarefrigeration
Fabbricante - Constructeur - Manufacturer Hersteller - Fabricante - Fabricante	Epta Spa - Via Mecenate, 86 - 20138 Milano (MI) ITALIA Tel. 02/55403211 Telefax 02/55401023	7/20

4. TRANSPORTATION OF THE CABINET



1. Lifting points

Chart I

Model		Weight (kg)	Weight with packaging (kg)
2D	COMPACT	350	490
3D		500	550
2D EOL		350	490
2D	NARROW	350	490
3D		500	550
EOL 3D-S		500	550

Modello - Modèle - Model Modell - Modelo - Modelo	GRANSESIA	COSTAN eptarefrigeration
Fabbricante - Constructeur - Manufacturer Hersteller - Fabricante - Fabricante	Epta Spa - Via Mecenate, 86 - 20138 Milano (MI) ITALIA Tel. 02/55403211 Telefax 02/55401023	8/20

IT
FR
EN
DE
ES
PT

5. AMBIENT CONDITIONS



Fig. 7



Fig. 9

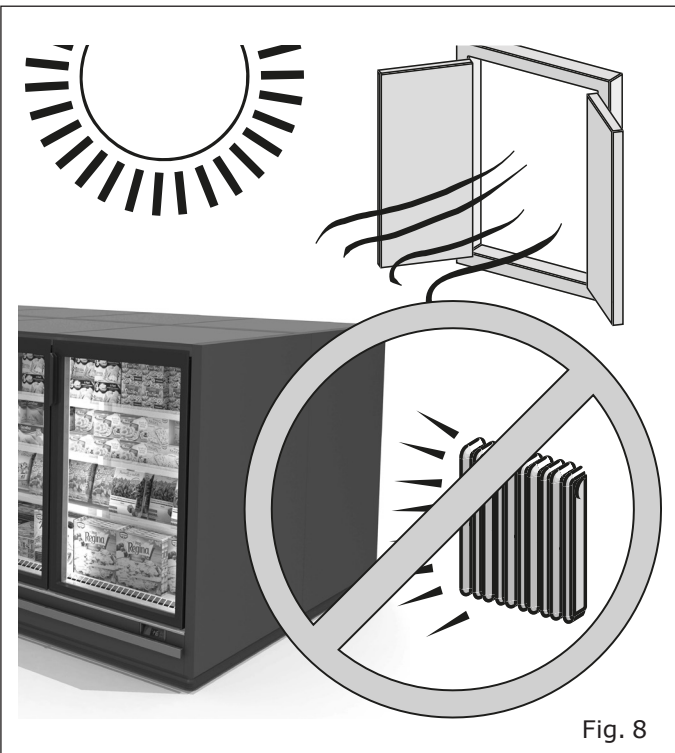

Fig. 8

Chart II

Characteristics	
Type of premises	Closed
Temperature	25°C
Relative humidity	60 %
Lighting	600 lx

Modello - Modèle - Model Modell - Modelo - Modelo	GRANSESIA	COSTAN eptarefrigeration
Fabbricante - Constructeur - Manufacturer Hersteller - Fabricante - Fabricante	Epta Spa - Via Mecenate, 86 - 20138 Milano (MI) ITALIA Tel. 02/55403211 Telefax 02/55401023	9/20

6. TECHNICAL FEATURES





			
1 2		SN 13 14 REF 15 16	
RATED BEMESSUNG ASSIGNÉ NOMINALE NOMINAL	3 4 5 6	REFRIGERANT KÄLTEMITTEL RÉFRIGÉRANT REFRIGERANTE REFRIGERANTE	17 18 19 20
DEFROSTING ABTAUUNG DÉGIVRAGE SBRINAMENTO DESCONGELAMIENTO	7 8	CLIMATIC CLASS KLIMAKLASSE CLASSE CLIMATIQUE CLASSE CLIMATICA CLASE CLIMÁTICA	21
HEATING SYSTEMS HEIZUNGSSYSTEME SYSTEMES CHAUFFANTS SISTEMI DI RISCALDAMENTO SISTEMA DE CALEFACCIÓN	9	INSULATION BLOWING GAS ISOLATIONSGAS (BLÄHGAS) AGENT MOUSSANT D' ISOLATION GAS ESPUMANTE ISOLAMENTO AGENTE ESPUMANTE	22
	10	PROTECTION INDEX SCHUTZART INDEX DE LA PROTECTION INDICE DI PROTEZIONE ÍNDICE DE PROTECCIÓN	23
	11	24	
Read Operator's Manual available at www.eptarefrigeration.com or calling +39 0437 968379			

Fig. 10

- | | |
|--|---|
| <ol style="list-style-type: none"> 1. Origin of the product 2. Product in "Country of origin" 3. Rated voltage 4. Rated power 5. Rated frequency 6. Rated current 7. Defrosting power 8. Defrosting current 9. Heating system 10. Lighting system 11. Operator manual 12. Barcode 13. Serial number | <ol style="list-style-type: none"> 14. Date of production 15. Hat Code 16. Model 17. Type of refrigerant 1 18. Refrigerant mass 1 19. Type of refrigerant 2 20. Refrigerant mass 2 21. Climate class 22. Gas isolation 23. Protection index 24. Certification brands 25. WEEE brand |
|--|---|





It is compulsory to use internal dividers between shelves and at the base to ensure correct operation of the cabinet. For the 3-door version the dividers are supplied as standard.

Modello - Modèle - Model Modell - Modelo - Modelo	<h1>GRANSESIA</h1>	
Fabbricante - Constructeur - Manufacturer Hersteller - Fabricante - Fabricante	Epta Spa - Via Mecenate, 86 - 20138 Milano (MI) ITALIA Tel. 02/55403211 Telefax 02/55401023	10/20

IT
FR
EN
DE
ES
PT

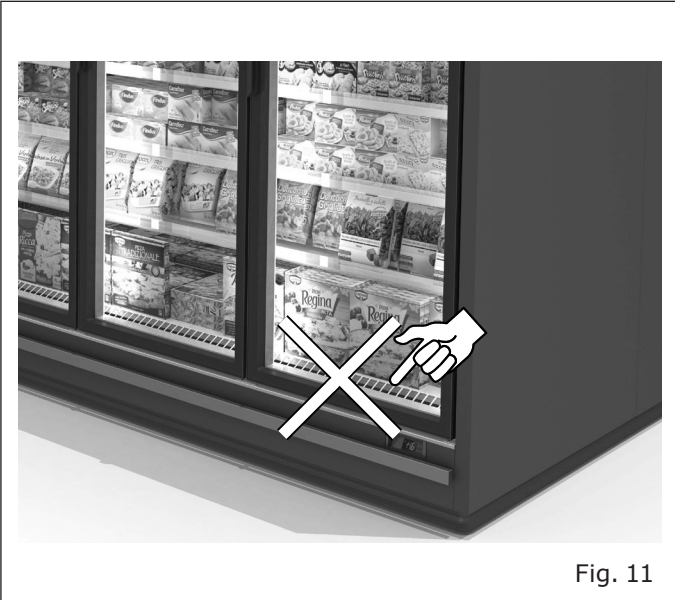
7. USE OF CABINET



 Do not cover

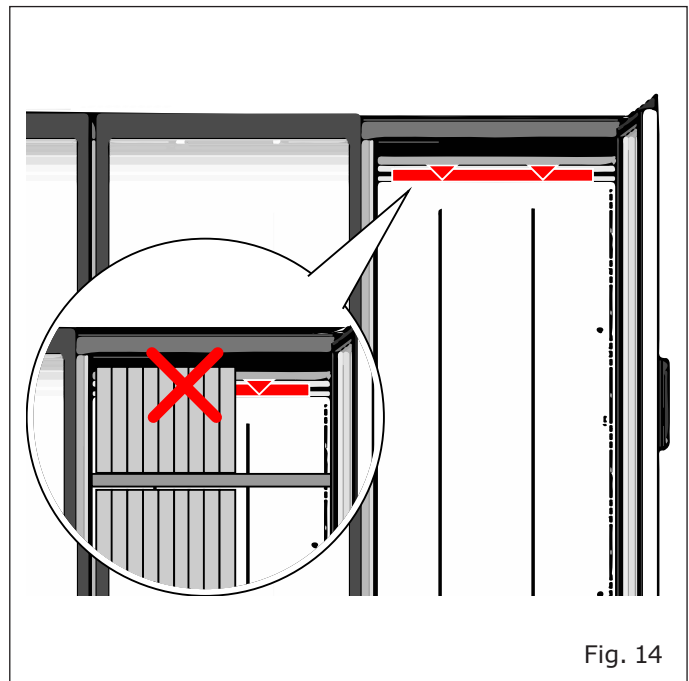
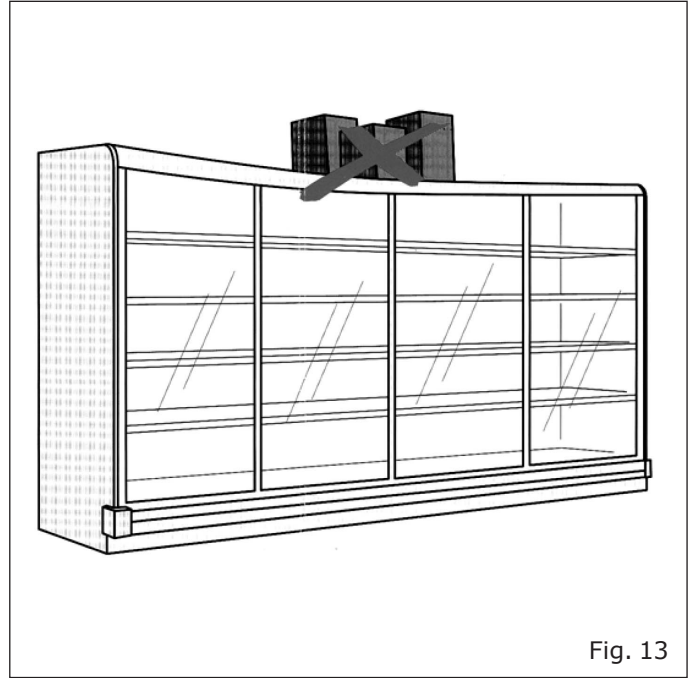

 Respecting the load line

Modello - Modèle - Model Modell - Modelo - Modelo	<h1>GRANSESIA</h1>	
Fabbricante - Constructeur - Manufacturer Hersteller - Fabricante - Fabricante	Epta Spa - Via Mecenate, 86 - 20138 Milano (MI) ITALIA Tel. 02/55403211 Telefax 02/55401023	11/20

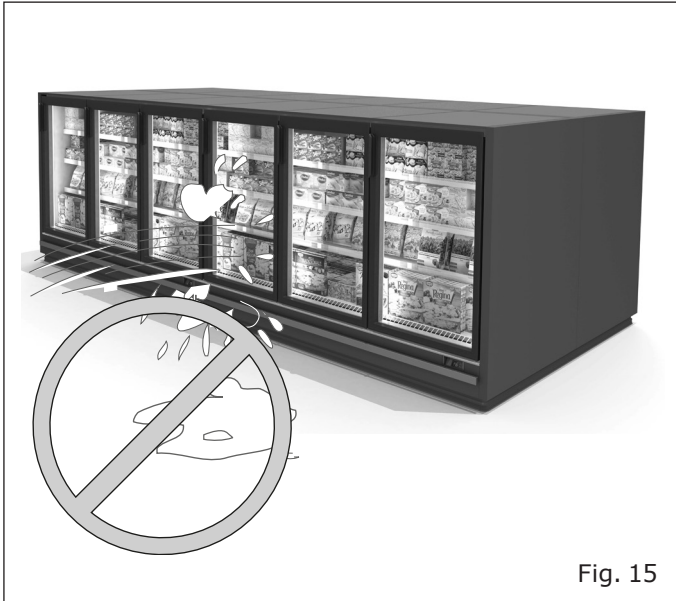

Fig. 15

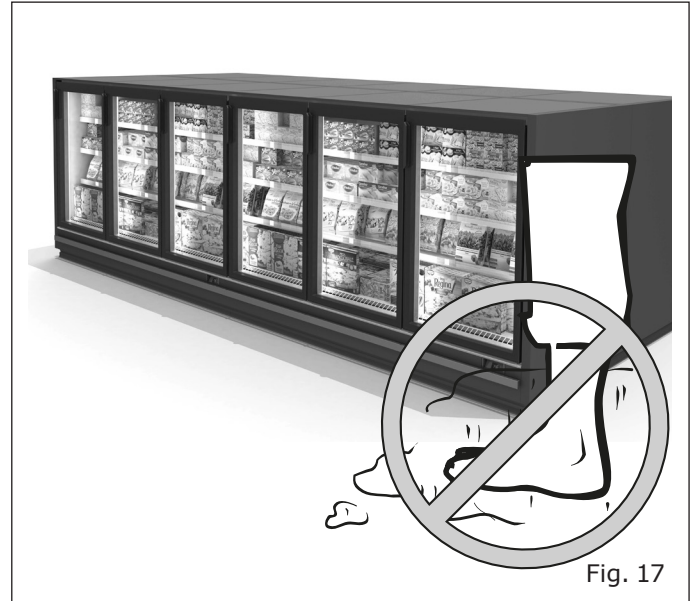

Fig. 17

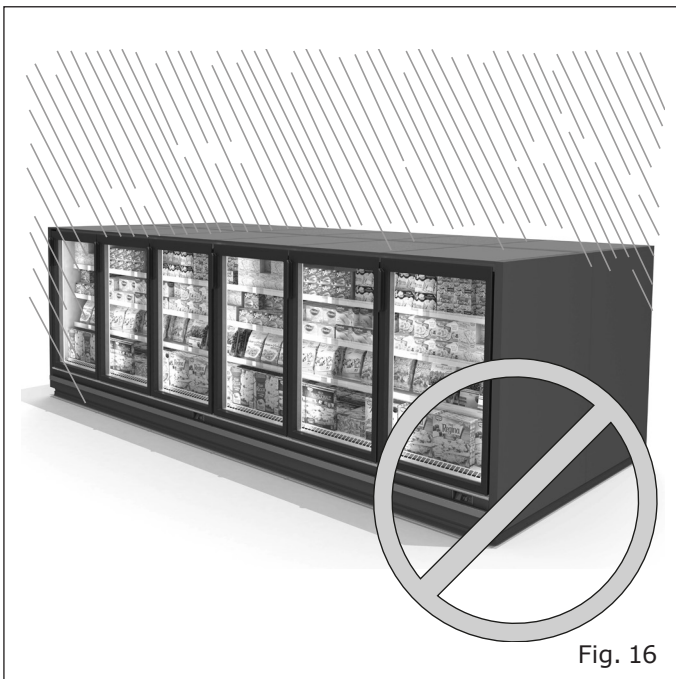

Fig. 16

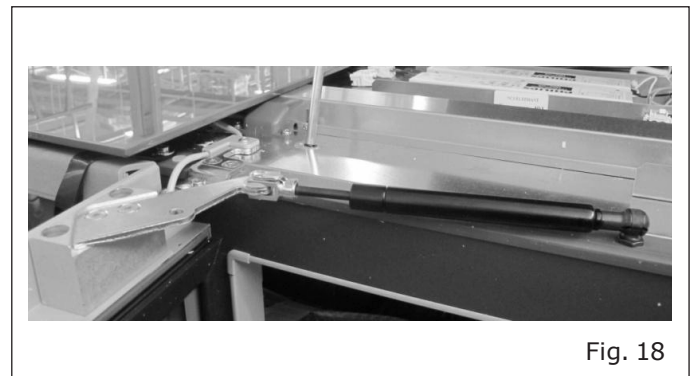

Fig. 18



Fig. 19

- IT
- FR
- EN**
- DE
- ES
- PT

Modello - Modèle - Model Modell - Modelo - Modelo	<h1>GRANSESIA</h1>	
Fabbricante - Constructeur - Manufacturer Hersteller - Fabricante - Fabricante	Epta Spa - Via Mecenate, 86 - 20138 Milano (MI) ITALIA Tel. 02/55403211 Telefax 02/55401023	12/20

IT
FR
EN
DE
ES
PT



Fig. 20

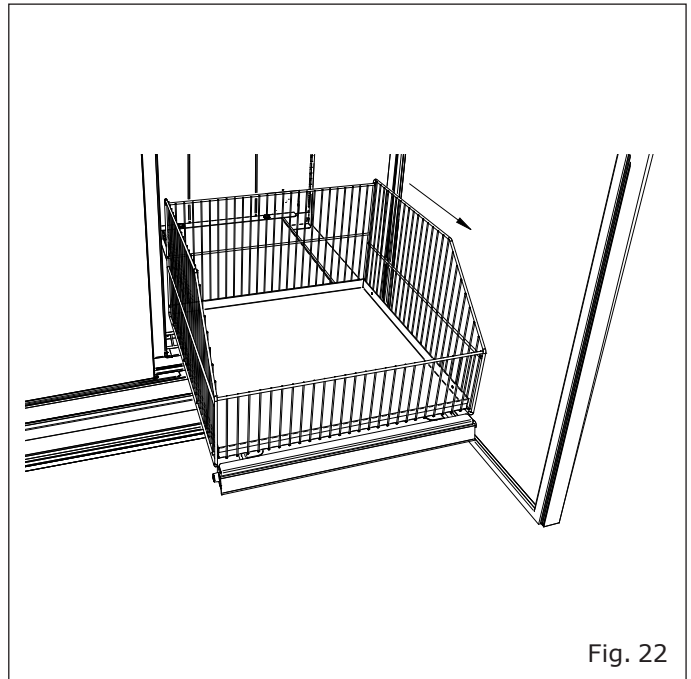

Fig. 22



Fig. 21

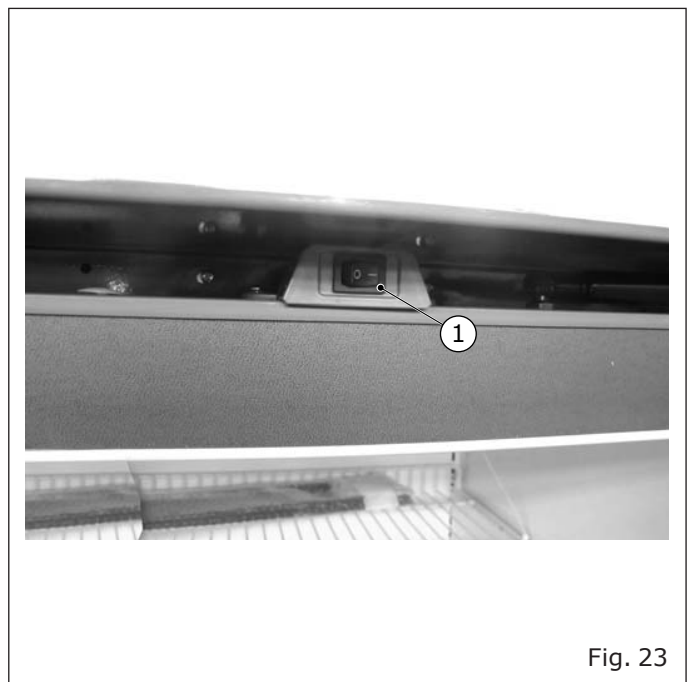

Fig. 23

1. Lighting Switch

Modello - Modèle - Model Modell - Modelo - Modelo	GRANSESIA	
Fabbricante - Constructeur - Manufacturer Hersteller - Fabricante - Fabricante	Epta Spa - Via Mecenate, 86 - 20138 Milano (MI) ITALIA Tel. 02/55403211 Telefax 02/55401023	13/20

8. ORDINARY MAINTENANCE

8.1 Cleaning the cabinet

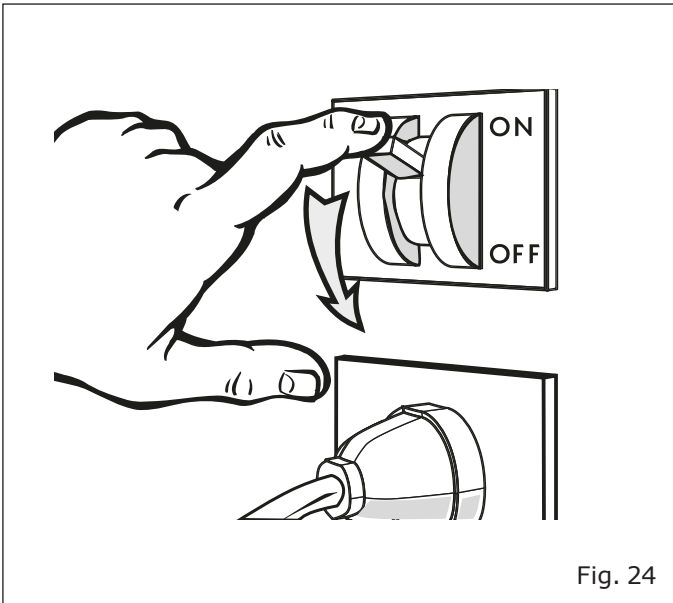

Fig. 24



Fig. 25

- IT
- FR
- EN**
- DE
- ES
- PT

Modello - Modèle - Model Modell - Modelo - Modelo	GRANSESIA	COSTAN eptarefrigeration
Fabbricante - Constructeur - Manufacturer Hersteller - Fabricante - Fabricante	Epta Spa - Via Mecenate, 86 - 20138 Milano (MI) ITALIA Tel. 02/55403211 Telefax 02/55401023	14/20

9. USER INDICATIONS

9.1 Description of the cabinet

This line of cabinets is suitable for the preservation and display of ice cream and frozen products.

TEMPERATURE CLASS (according to EN ISO 23953-2): 3L1.

The general characteristics and the dimensions are illustrated in the figures and in the sections contained in "General description" (to pg. "7").

During transport and handling, receipt and storage, installation, loading, use, cleaning and maintenance, dismantling, pay attention to the risk of overturning the cabinet ("Fig. 26").

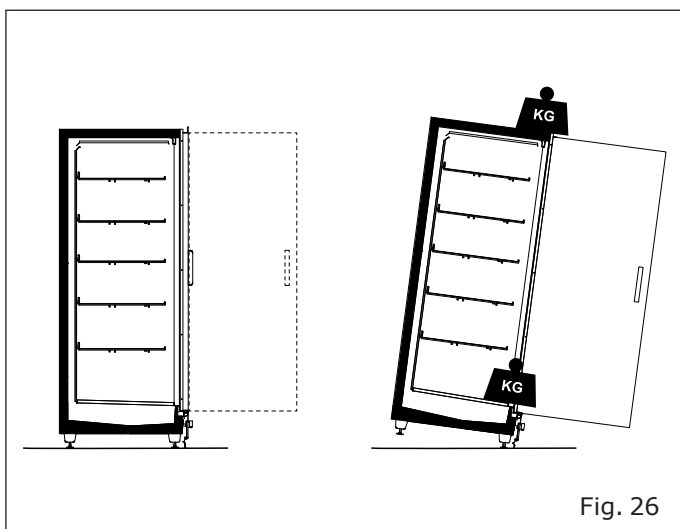

Fig. 26

9.2 Transport and handling

The cabinet is contained in a specific packaging equipped with a platform for handling with forklift trucks.

To transport and handle the cabinet use:

- Exclusively a dedicated or equivalent platform
- A manual or electric forklift suited to lifting the cabinet, with characteristics that comply with current Standards

The weights of the cabinet (empty and with packaging) and the dimensions of the packaging are shown in "Transportation of the cabinet" (chart "Chart I" and figures at pg."8").

The handling operations must be carried out by qualified staff able to assess weights, lifting points and most suitable means in terms of safety and capacity.

9.3 Receipt and storage

Check conditions of the packaging before accepting the cabinet from the carrier.

If there is obvious damage in the packaging:

- Remove the packaging of the cabinet in the presence of the carrier.
- Sign the delivery document with reservation.

The manufacturer shall not be held responsible for any damage caused due to transport or incorrect storage of the cabinet.

The cabinet must be stored in a place sheltered from sun and weather, with a temperature of between -25°C and +55°C and a relative humidity of the air between 30% and 95%.

Modello - Modèle - Model Modell - Modelo - Modelo	GRANSESIA	
Fabbricante - Constructeur - Manufacturer Hersteller - Fabricante - Fabricante	Epta Spa - Via Mecenate, 86 - 20138 Milano (MI) ITALIA Tel. 02/55403211 Telefax 02/55401023	15/20

9.4 Installation and ambient conditions

The cabinet is not designed to be installed outdoors.

For a correct operation of the cabinet, ensure that it is positioned:

- On a levelled floor ("Fig. 7").
- Far from heat sources, from the direct radiation of the sun, from doors, windows, fans and air vents ("Fig. 8").

Provide the space necessary for the use of the cabinet by the client.

The ambient conditions in which the cabinet should be placed are set out in "Ambient conditions".

9.5 Electrical connection

An omnipolar disconnecter switch must be installed upstream of the cabinet. This must have:

- Minimum distance of the contacts of 3 mm.
- Adequate breaking power

The disconnecter switch must be placed in a position that makes it easy to operate in emergency situations (maximum distance of 3 m).

Before connecting the cabinet, ensure that the supply voltage corresponds to the rating plate data of the cabinet. To guarantee smooth operation, the maximum voltage variation must be between +/- 6% of the nominal value.

9.6 Technical features

The identification plate shows the characteristic technical data of the cabinet. Its position and the type of data are shown in "Technical features" ("Fig. 10").

Wiring diagrams, control instrument calibration lists, installation instructions and copy of the Declaration of Conformity are available on the website <https://documents.eptarefrigeration.com>.

The sound pressure level generated by the operation of the cabinet is lower than 70 dB(A). The cabinet does not cause harmful vibrations.

9.7 Loading the product

Energise the cabinet to start its cooling cycle, by acting on the general disconnecter switch mounted on the wall. After about 2 hours it is possible to load the cabinet.

The cabinet is suitable to maintain the temperature of the goods and not lower it; the foods, therefore, must be introduced inside it only if already cooled to the respective temperatures of preservation. Products which have been heated must never be introduced into the cabinet.

In the presence of glass fronts on the cabinet, it is recommended to load the goods when there is no customer in the sales area.

In loading the goods, ensure that:

- The load is homogeneous in terms of dimension and quality of the products
- The goods do not obstruct the correct flow of refrigerated air ("Fig. 11").
- The goods do not exceed the load line ("Fig. 14").

Uniformly distributed maximum permissible load:

- On the shelves: 160 kg/m²
- On the bottom level: 225 kg/m²

Modello - Modèle - Model Modell - Modelo - Modelo	GRANSESIA	COSTAN eptarefrigeration
Fabbricante - Constructeur - Manufacturer Hersteller - Fabricante - Fabricante	Epta Spa - Via Mecenate, 86 - 20138 Milano (MI) ITALIA Tel. 02/55403211 Telefax 02/55401023	16/20

IT
FR
EN
DE
ES
PT



The door has been designed to remain open WITHOUT ANY MECHANICAL BLOCKING SYSTEM, simply opening it 90°. Furthermore, the "soft-closing" system ensures a slow and gentle automatic closure in the final part without the need to force its closure. For this reason, it is NOT NECESSARY TO OPEN the door more than 90° and block it with weights or KEEP IT in position if it is already open 90° ("Fig. 19, "Fig. 21").



During the loading phase, if there are sliding baskets (optional), they must not all be removed at the same time ("Fig. 22").

9.8 Use of cabinet

Lighting

The cabinet lighting is controlled by a switch on the top right of the cabinet.

Thermostat/thermometer

A remote thermostat/thermometer is positioned on the bottom right of the cabinet to control the temperature.

9.9 Cleaning and ordinary maintenance

Good visibility in the intervention area is recommended, possibly using an additional light source.



Anti-fogging coating of the doors LOW CONSUMPTION. The doors of the cabinet have an anti-fogging coating which prevents the formation of fog in any temperature condition and humidity, even after prolonged immersions in water or frequent cleaning. Extremely hydrophilic, the coating produces drops of water which propagate and do not, therefore, turn into fog. Though absorbing the humidity, the coating does not melt in water and, consequently, is not stained if wet. The film is not damaged by commercial detergents for glass, stain removers, ammonia, alcohol and petrol and does not discolour when exposed to sun or heat.

The doors are provided with laminated anti-fogging coating on the inner glass and protected by a layer.

The protective layer is partially raised on the sides to facilitate its removal during use. The protective layer must be removed after the doors have been installed on the cabinet once the cabinet has reached the operating temperature. This is to allow immediate operation of the anti-fogging film.

To recall this passage, the following label is attached to the protective film: " DO NOT REMOVE THE PROTECTIVE FILM UNTIL THE CABINET HAS REACHED THE OPERATING TEMPERATURE".

Modello - Modèle - Model Modell - Modelo - Modelo	GRANSESIA	COSTAN eptarefrigeration
Fabbricante - Constructeur - Manufacturer Hersteller - Fabricante - Fabricante	Epta Spa - Via Mecenate, 86 - 20138 Milano (MI) ITALIA Tel. 02/55403211 Telefax 02/55401023	17/20

Cleaning the cabinet

Only use water at a maximum temperature of 65°C and household soap or neutral detergent diluted in water.

For glass surfaces use only products for cleaning glass. It is recommended to avoid the use of water since it may deposit limestone on the surface of the glass.

Never use:

- Abrasive sponges
- Flammable or abrasive products such as alcohol, acetone or solvents
- Detergents that contain non-ionic surfactants, lemon or vinegar (acetic acid)



Do not wash or clean the top part of the cabinet with water or liquids.

Clean all the external parts of the cabinet **ONCE A WEEK**.

Clean all the internal parts of the cabinet **ONCE A MONTH**, following the instructions below:

- Disconnect the power supply to the cabinet using the wall-mounted main switch-disconnector ("Fig. 24").
- Empty the cabinet, storing the goods in cold rooms or refrigerators to maintain the preservation temperature.
- Wait for the inside of the cabinet to have reached the ambient temperature and then clean
- After carefully checking that the inside of the cabinet is completely dry, restart the appliance by re-energising the cabinet.
- After a couple of hours, load the goods again.

When you put the cabinet out of service, disconnect the power and follow the passages above, leaving the doors open (if available) to avoid odours.

Defrost the cabinet **EVERY THREE MONTHS** to allow the ice to melt which may have formed on the fins of the evaporator preventing correct operation. The duration of the defrosting activity is regulated directly in the factory. Any adjustments are reserved exclusively for the technical service department. The defrosting water is collected by a special drain. Periodically check that the defrosting water drains normally. If not, intervene immediately using a non-pointed flexible probe.

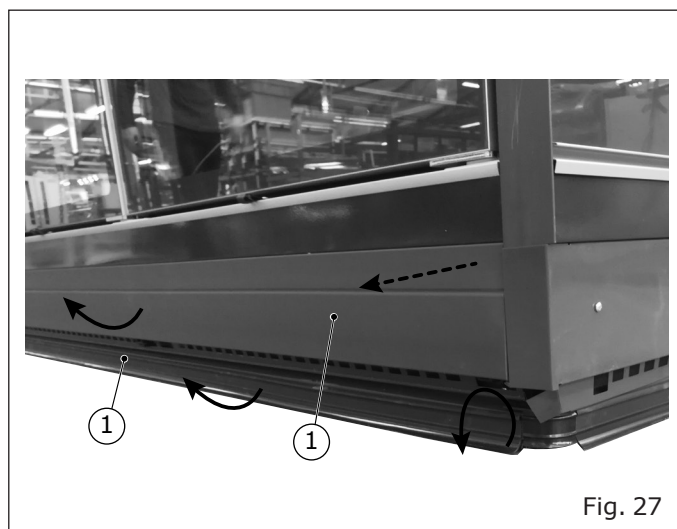

Fig. 27

1. Remove

Do as indicated to clean the internal parts **MONTHLY**, but in this case foresee a longer waiting time to allow the ice to melt completely.

Modello - Modèle - Model Modell - Modelo - Modelo	GRANSESIA	COSTAN eptarefrigeration
Fabbricante - Constructeur - Manufacturer Hersteller - Fabricante - Fabricante	Epta Spa - Via Mecenate, 86 - 20138 Milano (MI) ITALIA Tel. 02/55403211 Telefax 02/55401023	18/20

IT 9.10 Emergency situations

The cabinet does not start or it stops:

- Check there is no electrical blackout.
- Check that the main power switch on the wall is on.
- Check the cabinet plug is inserted into the socket.

If the power outage does not depend on these reasons, contact the nearest authorised service centre and empty completely and immediately store the product in cold rooms or refrigerators that can maintain the preservation temperature.

The cabinet does not cool sufficiently:

- Check that the cabinet is loading correctly.
- Defrost the cabinet and then resume normal operation, if this operation has not been carried out for more than three months.
- Check that the cabinet is not close to heat sources or air currents.
- Verify the ambient conditions; the reference values are contained in "Ambient conditions" ("Chart II").
- Check the flatness of the cabinet using a leveller.

If cooling failure persists, contact your nearest authorised service centre.

The cabinet is noisy:

- Check screws and bolts are perfectly tightened.
- Check the flatness of the cabinet using a leveller.

If the inconvenience persists, contact your nearest authorised service centre.

9.11 Technical assistance

Where technical assistance personnel are required, contact immediately the supplier from whom the cabinet was purchased.

If you need to use spare parts always refer to the technical assistance service: ask and ensure that original spare parts are used.

9.12 Dismantling and elimination

In accordance with the rules for dismantling waste in force in the individual Countries and to respect the environment in which we live, we ask you to separate the parts of the cabinet so that they can be disposed of separately or, if necessary, recover them appropriately.

Not all parts of the cabinet are comparable to municipal solid waste with the exception of the metallic parts that, in any case, are not included in special waste for the majority of European Countries.



The refrigeration system is high pressure. Contact expert staff before disposing of it.

The components of the refrigeration circuit must not be cut and/or separated before the circuit is discharged, with the recovery of refrigerant gas by qualified personnel.

Modello - Modèle - Model Modell - Modelo - Modelo	GRANSESIA	COSTAN eptarefrigeration
Fabbricante - Constructeur - Manufacturer Hersteller - Fabricante - Fabricante	Epta Spa - Via Mecenate, 86 - 20138 Milano (MI) ITALIA Tel. 02/55403211 Telefax 02/55401023	19/20

10. SUPPLEMENTARY GENERAL WARNINGS

Instructions for correct installation and maintenance

The user and maintenance instructions are found in the User Manual available on the website:

www.eptarefrigeration.com.

The installation instructions dedicated to expert staff are available:

- From the service network.
- In some categories of product in paper format delivered together with the product.

Professional repair services

The services are provided by our service network which can be consulted in the contacts area at the website address www.eptarefrigeration.com.

Spare parts

The spare parts and the information for the repair of the appliance are available for at least 8 years after the product is declared out of production at the following web address: www.epta-service.com/service.

The log-in credentials are provided on request to send via mail to: servicesupport@eptarefrigeration.com.

Cleaning air condenser

The incorporated unit appliances with air condensation maintain their efficiency only if the condenser is cleaned using the methods and times indicated in the user and maintenance manual.

Important information on food waste

It is recommended to follow attentively the instructions of preservation shown in the packages of the products and the indications provided by the food producers.

Therefore, the temperature settings must be suited to the characteristics of preservation of the food products consistently in accordance with the indications set out in our technical documentation.

Incorrect uses can result in deterioration.

Ambient conditions

This appliance is intended to function in environments in which the temperature and humidity fall within the limits provided for in the User and maintenance manual.

Instructions for disassembly

For disassembly activities, it is necessary to contact the professional operators.

Epta group has always been driven by a particular attention to the environment. It makes available to users the manuals for dismantling and treating the waste of the plug-in refrigerated cabinets, which can be downloaded below.

- Manual for dismantling open plug-in cabinets:



- Manual for dismantling closed plug-in cabinets:



Other information

For further and more detailed information, please refer to www.eptarefrigeration.com and to EPREL which is accessed through the QR code here or in the energy label of the product.



Modello - Modèle - Model Modell - Modelo - Modelo	GRANSESIA	COSTAN <small>eptarefrigeration</small>
Fabbricante - Constructeur - Manufacturer Hersteller - Fabricante - Fabricante	Epta Spa - Via Mecenate, 86 - 20138 Milano (MI) ITALIA Tel. 02/55403211 Telefax 02/55401023	20/20

IT

Limits of application

FR



This cabinet is designed for the use, transport and storage of up to a maximum altitude of 2000 m above sea level.

EN

DE

ES

PT

Storage:

- Temperature between 15°C and 50°C.
- Relative humidity between 20% and 90%.
- Maximum time 6 months.

Transport:

- Temperature between 20°C and 70°C.
- Relative humidity between 20% e 90%.
- Maximum time 2 months.

Installation:

- Temperature between 0°C and 40°C.
- Relative humidity between 20% and 90%.
- Maximum time 2 months.

Use:

The performance of the cabinet is not guaranteed outside of its normal use. Its integrity and safety is guaranteed within the following limits for temporary conditions.

Environment outside of the cabinet:

- From class 1 (16°C / 80%rh) to class 4 (30°C / 55%rh) or class 6 (27°C / 70%rh).

Environment inside the cabinet (conditions for electrical safety):

Positive temperature cabinet

- Temperature between -10°C and +10°C.
- Relative humidity between 70% and 100%.
- Maximum time 10 years.

Negative temperature cabinet

- Temperature between -40°C and 15°C.
- Relative humidity between 90% and 100%.
- Maximum time 10 years.



During operation, the heating elements could locally record temperatures higher than the aforementioned limits, however always in full respect of the safety conditions.

Modello - Modèle - Model Modell - Modelo - Modelo	GRANSESIA	COSTAN <small>eptarefrigeration</small>
Fabbricante - Constructeur - Manufacturer Hersteller - Fabricante - Fabricante	Epta Spa - Via Mecenate, 86 - 20138 Milano (MI) ITALIA Tel. 02/55403211 Telefax 02/55401023	1/20

VERZEICHNIS

1.	Einführung	2	
2.	Sicherheitshinweise	3	
	2.1 Allgemeine Hinweise	3	
	2.2 Wartungshinweise für das Kühlmöbel	4	
	2.3 Elektrische Warnhinweise	5	
	2.4 Verbote	5	
3.	Allgemeine Beschreibung	6	
	3.1 Schnittbilder	6	
4.	Transport des Kühlmöbels	7	
5.	Umgebungsbedingungen	8	
6.	Technische eigenschaften	9	
7.	Verwendung des Kühlmöbels	10	
8.	Wartung des möbels	13	
	8.1 Die Reinigung des Kühlmöbels	13	
9.	Hinweise für den Nutzer	14	
	9.1 Beschreibung des Kühlmöbels	14	
	9.2 Transport und Bewegung des Kühlmöbels	14	
	9.3 Empfang und Lagerung des Möbels	14	
	9.4 Installation und Umgebungsbedingungen	15	
	9.5 Elektrischer Anschluss	15	
	9.6 Technische eigenschaften	15	
	9.7 Die Befüllung des Kühlmöbels	15	
	9.8 Verwendung des Kühlmöbels	16	
	9.9 Reinigung und regelmäßige Wartung	16	
	9.10 Gefahrensituationen	18	
	9.11 Technischer Wartungsdienst	18	
	9.12 Demontage und Entsorgung	18	
10.	Allgemeine ergänzende Hinweise	19	

VERWENDETE SYMBOLE



Symbol für ein Verbot: Verbieht bestimmte Handlungen.



Gefahrensymbol: Regeln zur Unfallvermeidung für den Benutzer.



Symbol für einen Warnhinweis: Möglicherweise kann ein Schaden am Gerät und/oder an einer der Komponenten entstehen.



Symbol für einen Hinweis: Es folgen nützliche Informationen.

Modello - Modèle - Model Modell - Modelo - Modelo	GRANSESIA	COSTAN eptarefrigeration
Fabbricante - Constructeur - Manufacturer Hersteller - Fabricante - Fabricante	Epta Spa - Via Mecenate, 86 - 20138 Milano (MI) ITALIA Tel. 02/55403211 Telefax 02/55401023	2/20

IT

1. EINFÜHRUNG

FR

Es wird empfohlen, den Inhalt des vorliegenden Handbuchs zu lesen und es gemeinsam mit dem Kühlmöbel aufzubewahren.

EN

Der Hersteller lehnt jede Haftung für Personen- oder Sachschäden ab, die durch Nichtbeachtung der in diesem Handbuch enthaltenen Warnhinweise entstehen.

DE

ES

PT



Das vorliegende Handbuch enthält Informationen, die für die ordnungsgemäße Verwendung und Funktionsweise des Kühlmöbels notwendig sind.

Es enthält die folgenden Erläuterungen und Informationen:

- Eine Funktionsbeschreibung des Kühlmöbels, inklusive all seiner Komponenten
- Informationen über die für dieses Gerät geltenden Sicherheits- und Unfallverhütungsvorschriften
- Hinweise zur korrekten Verwendung des Kühlmöbels
- Hinweise für die korrekte, routinemäßige und planmäßige Wartung, einschließlich der Reinigungsarbeiten

Die folgenden Informationen sind nicht im Handbuch enthalten:

- Installationsanleitungen

Für die korrekte Installation des Kühlmöbels verweisen wir auf die folgenden Dokumente:

- Technical Manual
- Quick Reference Instructions

Das vorliegende Handbuch richtet sich an die folgenden Berufsgruppen:

- **QUALIFIZIERTE MITARBEITER:** Qualifizierte Personen, die mit dem Betrieb, der Einstellung, der Reinigung und der regelmäßigen Wartung des Möbels betraut sind
- **SPEZIALISIERTE TECHNIKER:** Techniker, die von der im Vertrag angegebenen Stelle (Hersteller/Vertragshändler/Lieferfirma) geschult und befugt sind, die folgenden Arbeiten auszuführen: Installation, außerordentliche Wartung, Reparatur, Austausch und Inspektion des Kühlmöbels

Die Betriebsanleitungen sind auch erhältlich unter:
www.eptarefrigeration.com.

Die geltenden Vorschriften und Zertifizierungen für dieses Kühlmöbel entnehmen Sie bitte der Konformitätserklärung.

Bewahren Sie die Gebrauchsanweisung und für den Fall des Verkaufs immer auf.

Modello - Modèle - Model Modell - Modelo - Modelo	GRANSESIA	COSTAN <small>eptarefrigeration</small>
Fabbricante - Constructeur - Manufacturer Hersteller - Fabricante - Fabricante	Epta Spa - Via Mecenate, 86 - 20138 Milano (MI) ITALIA Tel. 02/55403211 Telefax 02/55401023	3/20

2. SICHERHEITSHINWEISE

2.1 Allgemeine Hinweise

 Der Hersteller lehnt jede Haftung für Personen- oder Sachschäden ab, die durch Nichtbeachtung der in diesem Handbuch enthaltenen Warnhinweise entstehen. Jede Person, die dieses Kühlmöbel verwendet, ist dazu aufgefordert, das vorliegende Benutzerhandbuch zu lesen.

 Der Arbeitgeber muss das Personal über die folgenden geltenden Vorschriften informieren: Über die Unfallgefahren, über die bestehenden Sicherheitsvorrichtungen für das Personal, über die Gefahren von Lärmemissionen und die allgemeinen Unfallverhütungsvorschriften.

 Dieses Kühlmöbel darf nur von Erwachsenen benutzt werden, die über die erforderlichen Kenntnisse verfügen und deren körperliche, sensorische oder geistige Fähigkeiten nicht beeinträchtigt sind; das Gerät ist nicht für die Benutzung durch Minderjährige (insbesondere 0 bis 3 Jahre alt) geeignet. Kinder dürfen auch unter der Aufsicht und Verantwortung von Erwachsenen nicht mit dem Kühlmöbel spielen.

 Jede andere nicht ausdrücklich in diesem Handbuch angegebene Verwendungen gelten als gefährlich. Soit kann der Hersteller nicht für Schäden haftbar gemacht werden, die durch falschen Anschluss, fehlerhafte oder nicht bestimmungsgemäße Verwendung verursacht wurden.

 Das Kühlmöbel darf nur von Personen benutzt werden, die mit der entsprechenden, passenden Schutzkleidung ausgestattet sind.

 Das Tragen von Handschuhen ist Vorschrift.

 Das Kühlmöbel darf keinen Witterungseinflüssen ausgesetzt werden.

 Das Kühlmöbel darf keinem direkten oder indirekten Wasserstrahl ausgesetzt werden.

 Berühren Sie das Kühlmöbel nicht mit nassen oder feuchten Händen oder Füßen. Benutzen Sie das Gerät niemals barfuß.

 Das Entfernen von Schutzvorrichtungen oder von Teilen der Verkleidung, für das der Einsatz von Werkzeug erforderlich ist, ist ausschließlich qualifiziertem Personal vorbehalten.

 Wenden Sie sich bitte an das nächstgelegene autorisierte Servicezentrum, um spezielle Zusatzausstattungen montieren zu lassen.

 Sämtliche Arbeiten sind ausschließlich durch qualifiziertes Personal durchzuführen. Das Gerät muss vor jedem Eingriff von der Stromzufuhr getrennt werden.

Modello - Modèle - Model Modell - Modelo - Modelo	GRANSESIA	COSTAN <small>eptarefrigeration</small>
Fabbricante - Constructeur - Manufacturer Hersteller - Fabricante - Fabricante	Epta Spa - Via Mecenate, 86 - 20138 Milano (MI) ITALIA Tel. 02/55403211 Telefax 02/55401023	4/20

IT
FR
EN
DE
ES
PT

 Weisen Sie jeden, der das Kühlmöbel benutzt, auf die Position des Trennschalters hin.

 Eingriffe am Thermostat sind ausschließlich dem autorisierten technischen Kundendienst vorbehalten.

 Achten Sie auf warme oder bewegliche Geräteteile. Diese sind mit einem entsprechenden Symbol gekennzeichnet.

 Verwenden Sie im Falle eines Brandes ausschließlich Trockenlöschgeräte, verwenden Sie kein Wasser zum Löschen der Flammen.

 Beschädigen Sie nicht den Kühlkreislauf.

 Vermeiden Sie Flammen oder Funken im Inneren des Geräts.

 Die Lüftungsöffnungen am Gehäuse des Geräts müssen stets frei bleiben.

 Verwenden Sie keine elektrischen Geräte in den Tiefkühlfächern des Möbels, wenn diese nicht dem vom Hersteller empfohlenen Typ entsprechen.

 Lagern Sie in diesem Gerät keine explosiven oder gefährlichen Stoffe, wie z.B. unter Druck stehende Behälter mit entflammbarem Treibmittel.

 Es dürfen keine Lasten auf das Kühlregal oben positioniert werden; Unverpackte Lebensmittel sollten nicht direkt ins Regal gelegt werden. Diese sollten in dafür geeignete Behälter gelegt werden.

 Stellen Sie keine Flüssigkeitsbehälter auf und gießen Sie keine Flüssigkeiten auf die Theke.

2.2 **Wartungshinweise für das Kühlmöbel**

 Der Zugriff auf die elektrischen Komponenten und/oder auf Teile, die den Einsatz von Werkzeug erfordern, ist qualifizierten Technikern vorbehalten.

 Vor der Durchführung von Wartungs- oder Reinigungsarbeiten muss die Stromzufuhr zum Kühlmöbel über Hauptschalter unterbrochen werden.

 Achten Sie auf warme oder bewegliche Geräteteile. Diese sind mit einem entsprechenden Symbol gekennzeichnet.

 Das Tragen von Handschuhen ist Vorschrift.

Modello - Modèle - Model Modell - Modelo - Modelo	GRANSESIA	COSTAN <small>eptarefrigeration</small>
Fabbricante - Constructeur - Manufacturer Hersteller - Fabricante - Fabricante	Epta Spa - Via Mecenate, 86 - 20138 Milano (MI) ITALIA Tel. 02/55403211 Telefax 02/55401023	5/20

2.3 Elektrische Warnhinweise



Vergewissern Sie sich, dass die Versorgungsspannung den Angaben auf dem Typenschild des Kühlmöbels entspricht.



Die Elektroinstallation muss von fachkundigen Technikern fachgerecht ausgeführt werden.



Die Abdeckung der Schalttafel darf nur durch qualifizierte Techniker entfernt werden.



Gemäß den Installationsvorschriften muss das Stromversorgungsnetz über eine allpolige Trennvorrichtung verfügen, die unter den Betriebsbedingungen der Überspannungskategorie III die vollständige Trennung vom Netz gewährleistet.



Die Installation des Kühlmöbels muss gemäß den Anweisungen des Herstellers durch qualifiziertes Personal erfolgen. Dabei müssen die im jeweiligen Bestimmungsland des Kühlmöbels geltenden Vorschriften für elektrische Betriebsmittel eingehalten werden.



Eine fehlerhafte Installation des Kühlmöbels kann Schäden an Personen, Tieren oder Dingen verursachen, für die der Hersteller nicht haftbar gemacht werden kann.



Wenn das Netzkabel beschädigt ist, muss es von autorisiertem Servicepersonal ersetzt werden. Versuchen Sie nicht, das Kabel zu reparieren.



Versorgen Sie die Bank nicht mit Strom, wenn sie beschädigt ist. Wenden Sie sich im Zweifelsfall an den Kundendienst oder Ihren Händler.

2.4 Verbote



Es ist verboten, andere als die vom Hersteller im Kühlmöbel mitgelieferten Geräte zu verwenden, um den Abtauvorgang zu beschleunigen.



Das Entfernen der Schalttafelabdeckung oder das Öffnen von Abdeckungen, die den Einsatz von Werkzeug erfordern, ist für nicht qualifiziertes Personal verboten.



Es ist verboten, das Kühlmöbel zur Aufbewahrung und/oder Präsentation von explosiven, entflammaren oder ätzenden Stoffen einzusetzen, wie z. B. Sprühdosen mit entflammarem Treibmittel.



Das Kühlmöbel darf nicht für die Aufbewahrung und/oder Auslage von Arzneimitteln verwendet werden.



BEI UNVERPACKTEN PRODUKTEN ODER BEI NIEDRIGEN TEMPERATUREN ist es verboten, dieses Kühlmöbel zur Lagerung und/oder Präsentation von Flaschen und Verpackungen aus Glas zu verwenden.



Es ist verboten, das Kühlmöbel in einer Umgebung aufzustellen, in der sich explosive, gasförmige Stoffe befinden.



Es ist verboten, das Typenschild des Kühlmöbels zu entfernen.



Das Betreten der Theke oder der Thekenstoßstange ist verboten.

IT

FR

EN

DE

ES

PT

Modello - Modèle - Model Modell - Modelo - Modelo	GRANSESIA	COSTAN eptarefrigeration
Fabbricante - Constructeur - Manufacturer Hersteller - Fabricante - Fabricante	Epta Spa - Via Mecenate, 86 - 20138 Milano (MI) ITALIA Tel. 02/55403211 Telefax 02/55401023	6/20

3. ALLGEMEINE BESCHREIBUNG

3.1 Schnittbilder

COMPACT

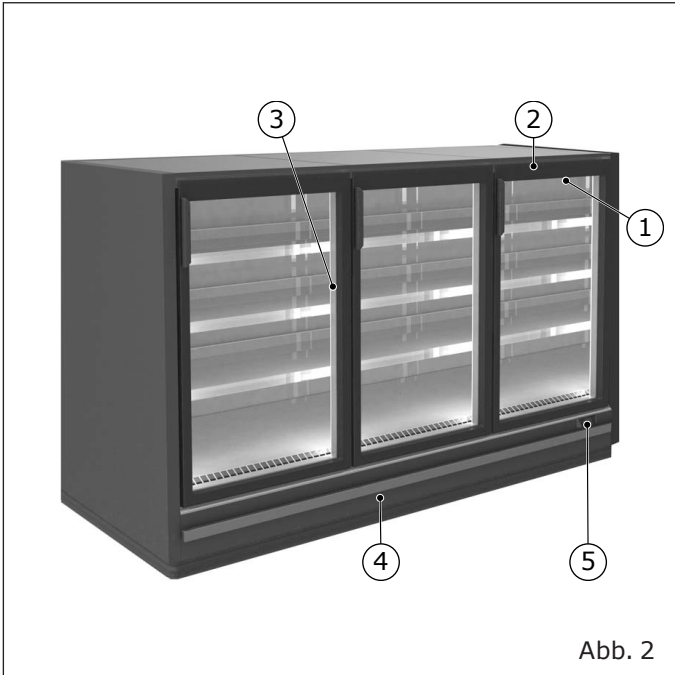

1. Typenschild
2. Lichtschalter
3. Beleuchtung
4. Stoßleiste (optional)
5. Fernthermostat

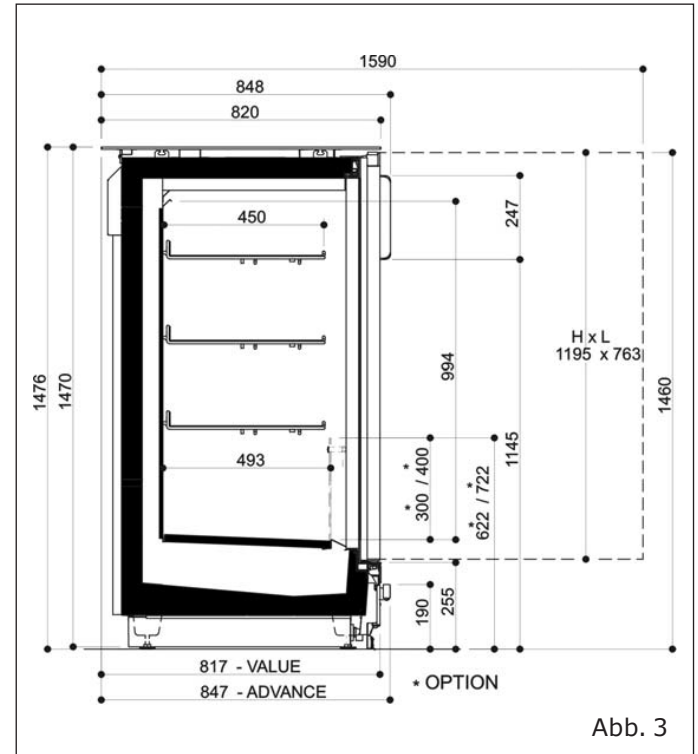

NARROW

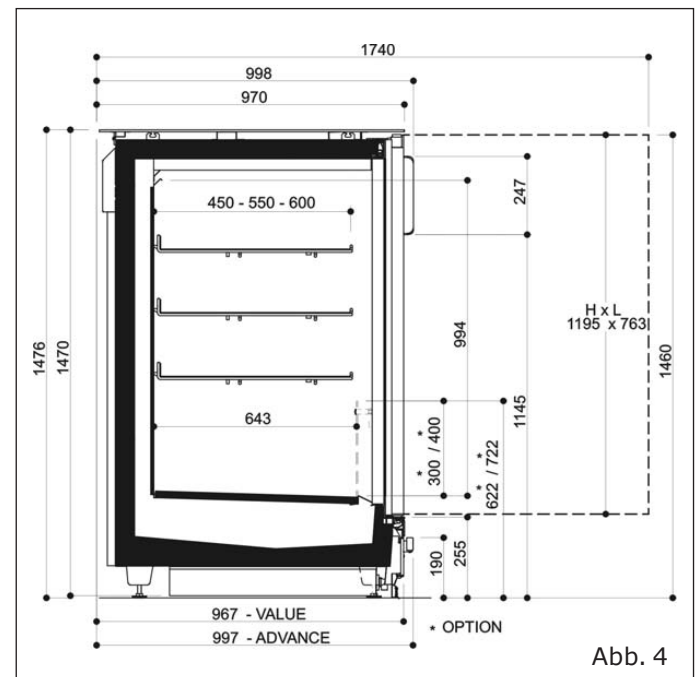

Modello - Modèle - Model Modell - Modelo - Modelo	GRANSESIA	COSTAN eptarefrigeration
Fabbricante - Constructeur - Manufacturer Hersteller - Fabricante - Fabricante	Epta Spa - Via Mecenate, 86 - 20138 Milano (MI) ITALIA Tel. 02/55403211 Telefax 02/55401023	7/20

4. TRANSPORT DES KÜHLMÖBELS



1. Hebepunkte

Tab. I

Modell		Gewicht (kg)	Gewicht mit Verpackung (kg)
2D	COMPACT	350	490
3D		500	550
2D EOL		350	490
2D	NARROW	350	490
3D		500	550
EOL 3D-S		500	550

Modello - Modèle - Model Modell - Modelo - Modelo	GRANSESIA	COSTAN eptarefrigeration
Fabbricante - Constructeur - Manufacturer Hersteller - Fabricante - Fabricante	Epta Spa - Via Mecenate, 86 - 20138 Milano (MI) ITALIA Tel. 02/55403211 Telefax 02/55401023	8/20

IT
FR
EN
DE
ES
PT

5. UMGEBUNGSBEDINGUNGEN



Abb. 7



Abb. 9



Abb. 8

Tab. II

Eigenschaften	
Art des Aufstellungsortes	Geschlossen
Temperatur	25°C
Relative Luftfeuchtigkeit	60 %
Beleuchtung	600 lx

Modello - Modèle - Model Modell - Modelo - Modelo	GRANSESIA	COSTAN eptarefrigeration
Fabbricante - Constructeur - Manufacturer Hersteller - Fabricante - Fabricante	Epta Spa - Via Mecenate, 86 - 20138 Milano (MI) ITALIA Tel. 02/55403211 Telefax 02/55401023	9/20

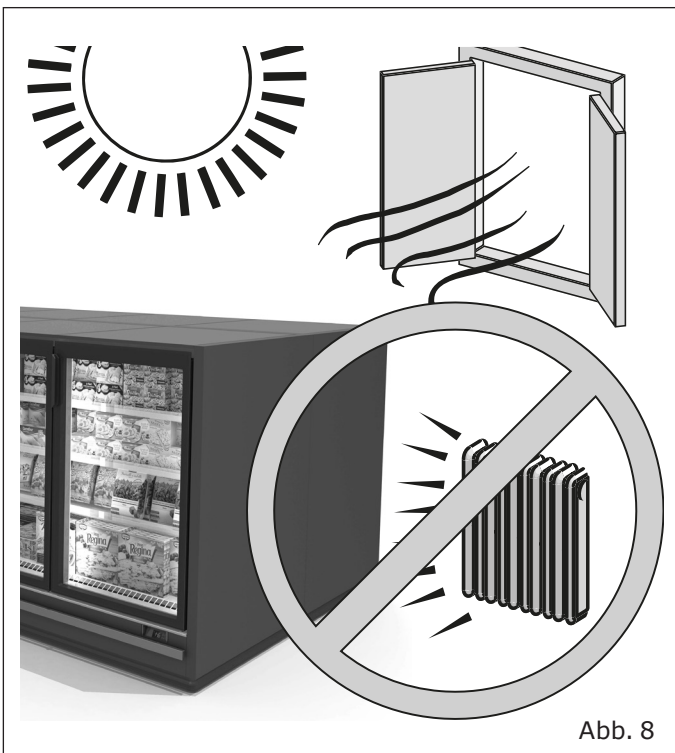
6. TECHNISCHE EIGENSCHAFTEN





 <small>EPTA S.p.A. Via Mecenate, 86 20138 Milano - Italy</small>			
1	2	SN 13	14
		REF 15	16
RATED BEMESSUNG ASSIGNÉ NOMINALE NOMINAL	3	4	REFRIGERANT KÄLTEMITTEL RÉFRIGÉRANT REFRIGERANTE REFRIGERANTE
	5	6	17
			18
			19
			20
DEFROSTING ABTAUUNG DÉGIVRAGE SBRINAMENTO DESCONGELAMIENTO	7		
	8	CLIMATIC CLASS KLIMAKLASSE CLASSE CLIMATIQUE CLASSE CLIMÁTICA	
		21	
HEATING SYSTEMS HEIZUNGSSYSTEME SYSTEMES CHAUFFANTS SISTEMI DI RISCALDAMENTO SISTEMA DE CALEFACCIÓN	9		
		INSULATION BLOWING GAS ISOLATIONSGAS (BLÄHGAS) AGENT MOUSSANT D' ISOLATION GAS ESPANDENTE ISOLAMENTO AGENTE ESPUMANTE	
		22	
	10	PROTECTION INDEX SCHÜTZART INDEX DE LA PROTECTION INDICE DI PROTEZIONE INDICE DE PROTECCIÓN	
		23	
	Read Operator's Manual available at www.eptarefrigeration.com or calling +39 0437 968379		24
	11	25	

Abb. 10

- | | |
|--|---|
| <ol style="list-style-type: none"> 1. Produktherkunft 2. Hergestellt in "Herstellungsland" 3. Nennspannung 4. Nennleistung 5. Nennfrequenz 6. Nennstrom 7. Abtauleistung 8. Strom für die Abtauautomatik 9. Heizsystem 10. Beleuchtungssystem 11. Betriebshandbuch 12. Barcode 13. Seriennummer | <ol style="list-style-type: none"> 14. Herstellungsdatum 15. Hat Code 16. Modell 17. Kältemittelart 1 18. Kältemittelmasse 1 19. Kältemittelart 2 20. Kältemittelmasse 2 21. Klimaklasse 22. Isolierung der Kältemittelleitung 23. Schutzklasse 24. Zertifizierungskennzeichen 25. WEEE-Kennzeichnung |
|--|---|



Für den korrekten Betrieb müssen zwischen den Etagern sowie auf der unteren Auslage Warentrenner montiert werden. Diese werden beim 3-Türer serienmäßig mitgeliefert.

Modello - Modèle - Model Modell - Modelo - Modelo	<h1>GRANSESIA</h1>	
Fabbricante - Constructeur - Manufacturer Hersteller - Fabricante - Fabricante	Epta Spa - Via Mecenate, 86 - 20138 Milano (MI) ITALIA Tel. 02/55403211 Telefax 02/55401023	10/20

IT
FR
EN
DE
ES
PT

7. VERWENDUNG DES KÜHLMÖBELS



 Nicht zudecken

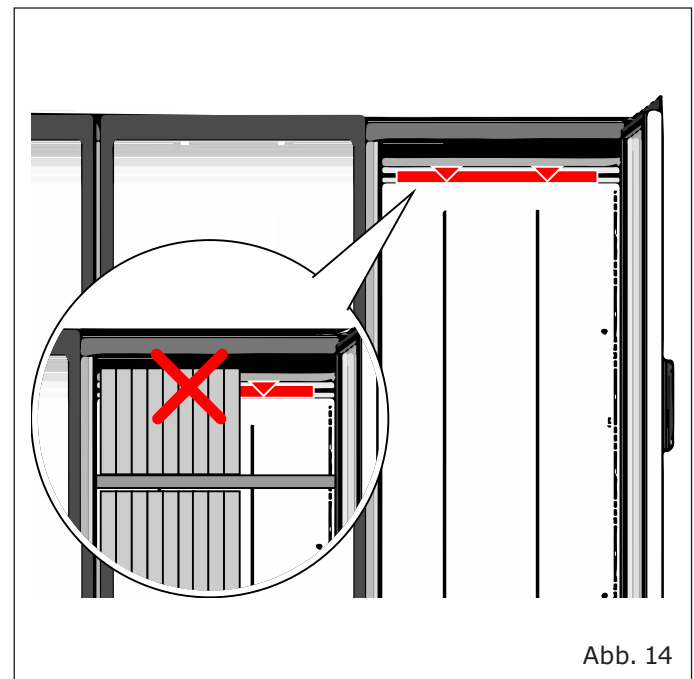
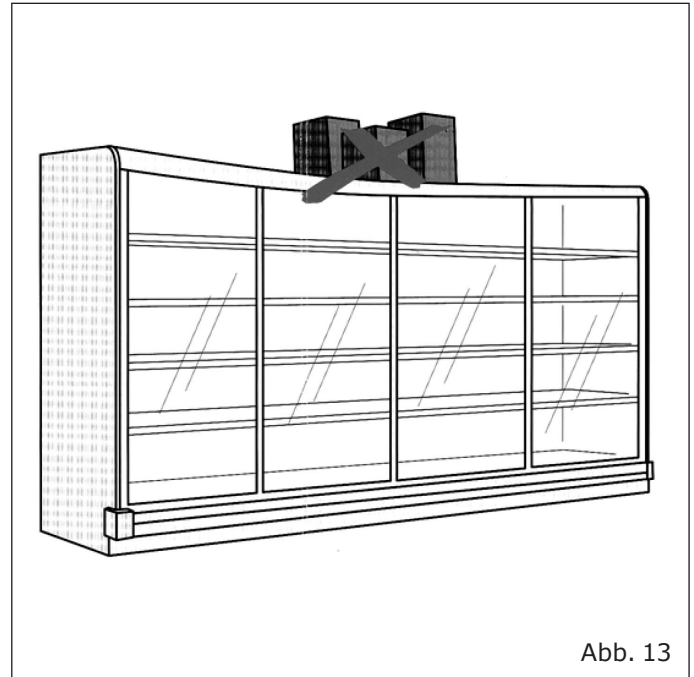

 Die Fülllinie nicht überschreiten

Modello - Modèle - Model Modell - Modelo - Modelo	<h1>GRANSESIA</h1>	
Fabbricante - Constructeur - Manufacturer Hersteller - Fabricante - Fabricante	Epta Spa - Via Mecenate, 86 - 20138 Milano (MI) ITALIA Tel. 02/55403211 Telefax 02/55401023	11/20

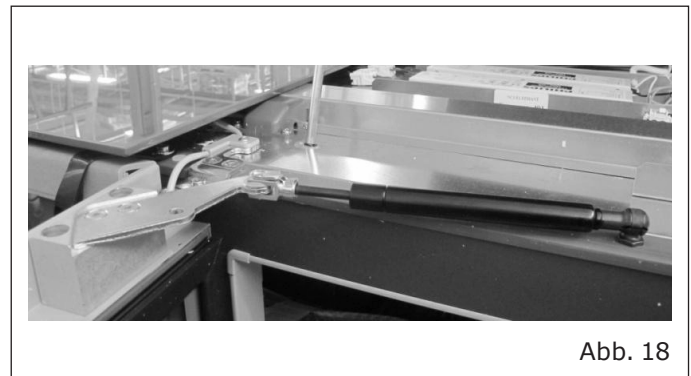
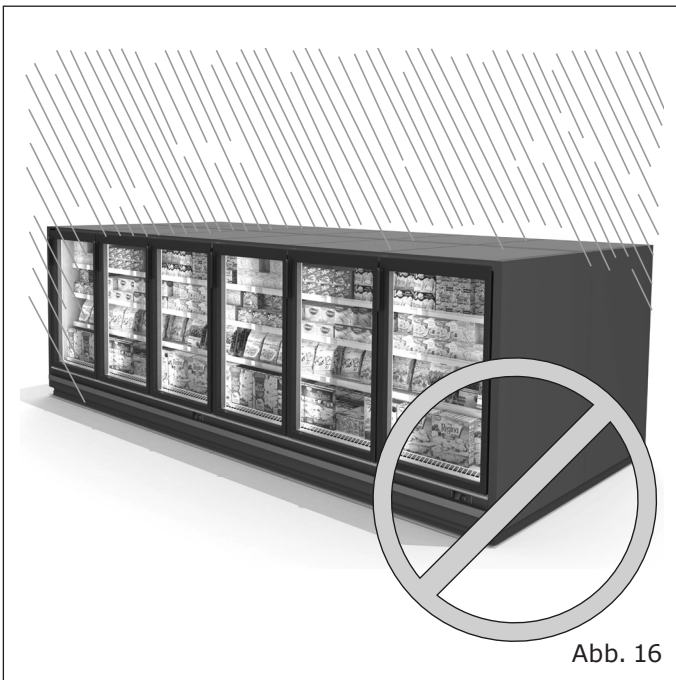
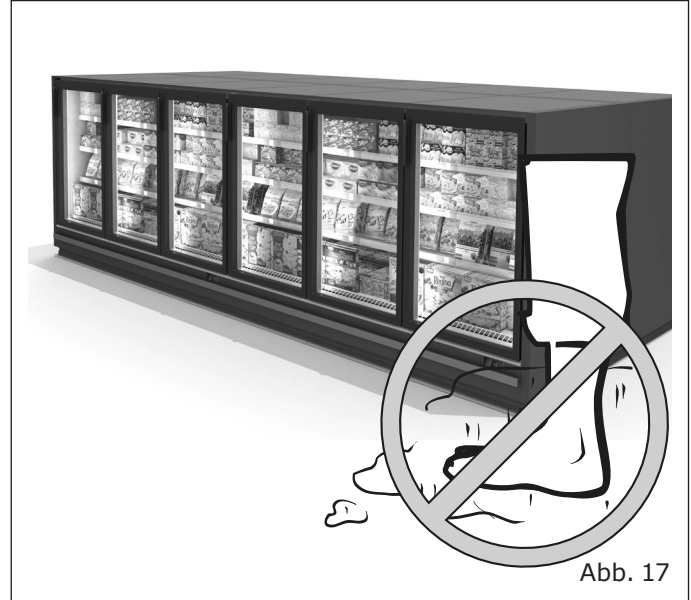

- IT
- FR
- EN
- DE
- ES
- PT

Modello - Modèle - Model Modell - Modelo - Modelo	<h1>GRANSESIA</h1>	
Fabbricante - Constructeur - Manufacturer Hersteller - Fabricante - Fabricante	Epta Spa - Via Mecenate, 86 - 20138 Milano (MI) ITALIA Tel. 02/55403211 Telefax 02/55401023	12/20

IT
FR
EN
DE
ES
PT



Abb. 20



Abb. 22



Abb. 21

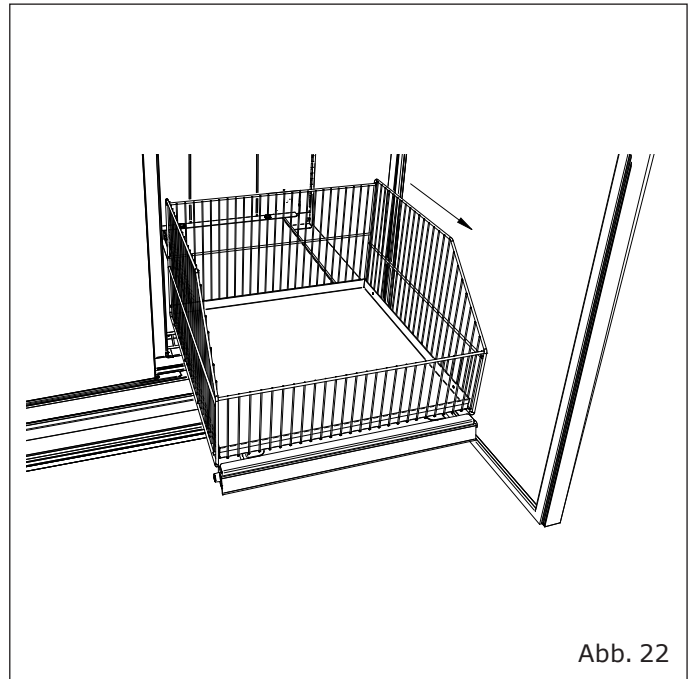

Abb. 23

1. Lichtschalter

Modello - Modèle - Model Modell - Modelo - Modelo	GRANSESIA	
Fabbricante - Constructeur - Manufacturer Hersteller - Fabricante - Fabricante	Epta Spa - Via Mecenate, 86 - 20138 Milano (MI) ITALIA Tel. 02/55403211 Telefax 02/55401023	13/20

8. WARTUNG DES MÖBELS

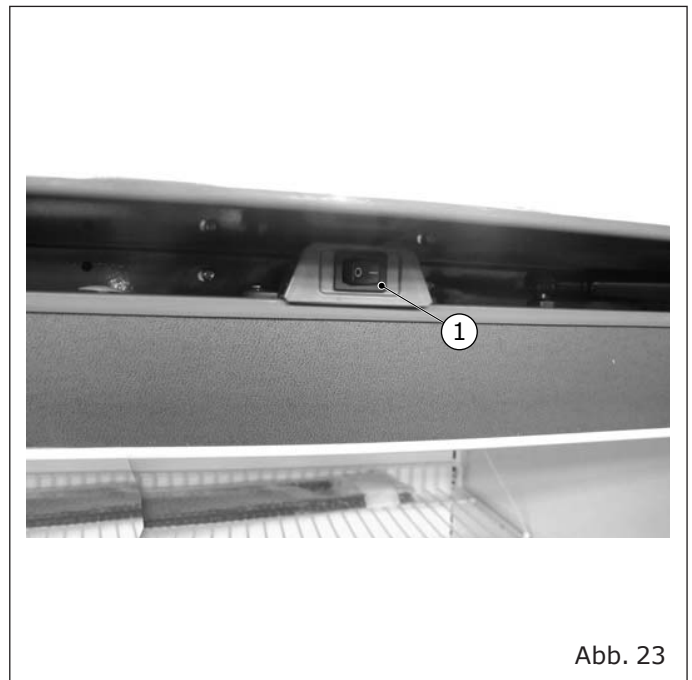
8.1 Die Reinigung des Kühlmöbels



Abb. 24



Abb. 25

Modello - Modèle - Model Modell - Modelo - Modelo	GRANSESIA	COSTAN eptarefrigeration
Fabbricante - Constructeur - Manufacturer Hersteller - Fabricante - Fabricante	Epta Spa - Via Mecenate, 86 - 20138 Milano (MI) ITALIA Tel. 02/55403211 Telefax 02/55401023	14/20

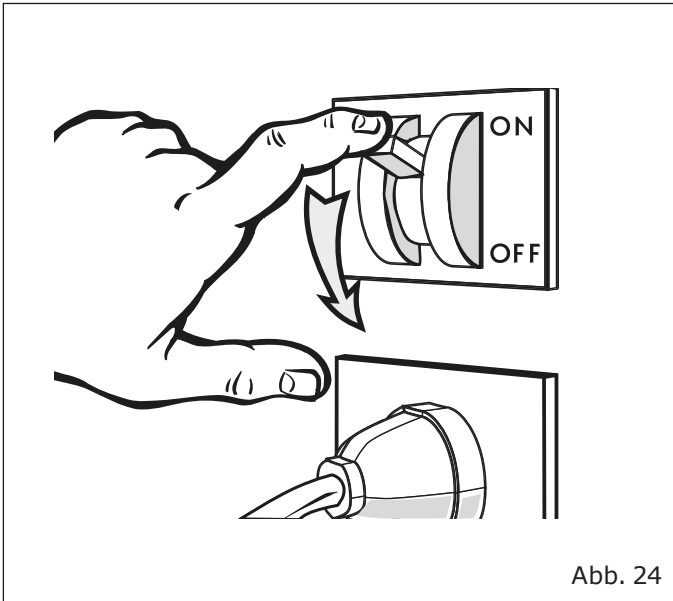
9. HINWEISE FÜR DEN NUTZER

9.1 Beschreibung des Kühlmöbels

Diese Kühlmöbelreihe ist für die Konservierung und Präsentation von Speiseeis geeignet.

TEMPERATURKLASSE (nach EN ISO 23953-2): 3L1.

Die allgemeinen Eigenschaften und die Abmessungen sind in den Abbildungen und in den Abschnitten der aufgeführt: "Allgemeine Beschreibung" (bis S. "7").

Beachten Sie, dass bei Transport, Handling, Anlieferung, Lagerung, Aufstellung, Beladung, Benutzung, Reinigung und Wartung sowie bei der Demontage die Gefahr besteht, dass das Gerät umkippt ("Abb. 26").



Abb. 26

9.2 Transport und Bewegung des Kühlmöbels

Das Möbel befindet sich in einer speziellen Verpackung mit einem Transportsockel für den Gabelstapler.

Verwenden Sie für die Bewegung des Möbels:

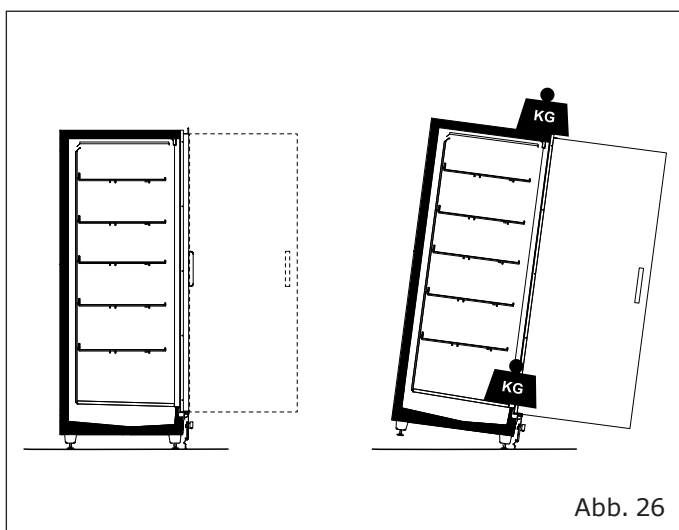
- Ausschließlich einen speziell geeigneten oder gleichwertigen Transportsockel
- Einen manuellen oder elektrischen Hubwagen, der für das Anheben des Möbels geeignet ist und über die vorgeschriebenen Eigenschaften verfügt

Das Gerätegewicht (Leergewicht und mit Verpackung) und die Abmessungen der Verpackung sind im Abschnitt aufgeführt: "Transport des Kühlmöbels" (Tabelle "Tab. I" und Abb. auf S. "8").

Die Durchführung der Positionierungsarbeiten muss durch qualifiziertes Personal erfolgen. Dieses muss in der Lage sein, das Gewicht, die Hebepunkte und die für die Sicherheit und Tragfähigkeit am besten geeigneten Hilfsmittel richtig einzuschätzen.

9.3 Empfang und Lagerung des Möbels

Überprüfen Sie den Zustand der Verpackung, bevor Sie das Gerät in Empfang nehmen. Sollte die Verpackung sichtbare Beschädigungen aufweisen:

- Entfernen Sie die Verpackung unter den Augen des Lieferanten.
- Quittieren Sie den Empfang des Dokuments unter Vorbehalt.

Der Hersteller haftet nicht für Schäden, die durch den Transport oder die unsachgemäße Lagerung des Kühlmöbels entstehen.

Das Gerät muss an einem Ort gelagert werden, der vor Sonneneinstrahlung und Witterungseinflüssen geschützt ist und in dem eine Temperatur zwischen -25°C und $+55^{\circ}\text{C}$ sowie eine Luftfeuchtigkeit zwischen 30% und 95% herrschen.

Modello - Modèle - Model Modell - Modelo - Modelo	GRANSESIA	
Fabbricante - Constructeur - Manufacturer Hersteller - Fabricante - Fabricante	Epta Spa - Via Mecenate, 86 - 20138 Milano (MI) ITALIA Tel. 02/55403211 Telefax 02/55401023	15/20

9.4 Installation und Umgebungsbedingungen

Das Gerät ist nicht für die Installation im Freien geeignet.

Für den korrekten Betrieb müssen bei der Positionierung des Geräts folgende Voraussetzungen erfüllt sein:

- Das Gerät muss auf einem ebenen Untergrund aufgestellt werden. ("Abb. 7").
- Es dürfen sich keine Wärmequellen, direkte Sonneneinstrahlung, Türen, Fenster, Ventilatoren oder Lüftungsöffnungen in der Nähe befinden ("Abb. 8").

Es muss genug Platz vorhanden sein, damit die Kundschaft das Gerät bedienen kann.

Die Hinweise zu den Umgebungsbedingungen, in denen das Gerät aufgestellt werden soll, finden Sie in "Umgebungsbedingungen".

9.5 Elektrischer Anschluss

Dem Gerät muss ein allpoliger Trennschalter vorgeschaltet werden. Dieser muss:

- einen Mindestabstand der Kontakte von 3 mm aufweisen.
- Über eine ausreichende Trennungsstärke verfügen

Der Trennschalter muss so montiert werden, dass er im Falle einer auftretenden Gefahrensituation einfach betätigt werden kann (Entfernung maximal 3 m).

Vergewissern Sie sich, dass die Netzspannung mit den Angaben auf dem Typenschild übereinstimmt, bevor Sie das Möbel an den Strom anschließen. Damit der ordnungsgemäße Betrieb gewährleistet ist, darf die Spannung insgesamt maximal zwischen +/- 6% vom Nennwert abweichen.

9.6 Technische eigenschaften

Auf dem Typenschild werden alle spezifischen technischen Gerätedaten angegeben. Sie finden seine Position und die Art der Angaben in "Technische eigenschaften" ("Abb. 10").

Sie finden die Schaltpläne, Kalibrierungslisten der Kontrollinstrumente, Installationsanweisungen sowie eine Kopie der Konformitätserklärung unter dem folgenden Link: <https://documents.eptarefrigeration.com>. Der durch den Betrieb des Geräts erzeugte Schalldruckpegel liegt unter 70 dB(A). Das Möbel erzeugt keine schädlichen Schwingungen.

9.7 Die Befüllung des Kühlmöbels

Schalten Sie das Gerät über den an der Wand montierten Hauptschalter ein, um den Kühlkreislauf zu starten. Etwa 2 später können Sie damit beginnen, das Kühlmöbel zu befüllen. Das Gerät ist dafür ausgelegt, die Temperatur der enthaltenen Waren aufrechtzuerhalten. Es ist nicht dazu ausgelegt, die Warentemperatur zu senken. Es sollten daher nur Waren in das Kühlmöbel gelegt werden, die bereits auf ihre jeweilige Lagertemperatur heruntergekühlt wurden. Sie sollten niemals Produkte im Kühlmöbel lagern, die sich zuvor erwärmt haben.

Wenn das Kühlmöbel über eine Frontverglasung verfügt, wird empfohlen, es außerhalb der Ladenöffnungszeiten zu befüllen.

Achten Sie beim Befüllen des Kühlmöbels darauf, dass:

- Das Kühlmöbel unter Berücksichtigung der Größe und Art der Waren gleichmäßig befüllt wird
- Die Waren nicht die Zirkulation der Kaltluft beeinträchtigen ("Abb. 11").
- Die Waren nicht die Fülllinie überschreiten ("Abb. 14").

Das zulässige Gesamtgewicht sich gleichmäßig im Kühlmöbel verteilt:

- Auf den Etagere: 160 kg/m²
- Untere Ablagefläche: 225 kg/m²

Modello - Modèle - Model Modell - Modelo - Modelo	GRANSESIA	COSTAN eptarefrigeration
Fabbricante - Constructeur - Manufacturer Hersteller - Fabricante - Fabricante	Epta Spa - Via Mecenate, 86 - 20138 Milano (MI) ITALIA Tel. 02/55403211 Telefax 02/55401023	16/20

IT
FR
EN
DE
ES
PT



Die Tür wurde - OHNE MECHANISCHES VERRIEGELUNGSSYSTEM - so konzipiert, dass sie offen bleibt, wenn sie in einem Winkel von 90° geöffnet wird. Außerdem sorgt das "soft closing"-Schließsystem dafür, dass die Tür sich automatisch, langsam und sanft - ohne weiteres Zutun - schließt. Wenn die Tür bereits in einem Winkel von 90° offensteht, ist es daher nicht nötig, sie NOCH WEITER ZU ÖFFNEN, um sie mit einem Gewicht zu fixieren oder in dieser Position zu halten ("Abb. 19, "Abb. 21").



Sofern das Kühlmöbel über Auszugskörbe (optional) verfügt, sollten diese beim Befüllen nicht alle gleichzeitig vorgezogen werden ("Abb. 22").

9.8 Verwendung des Kühlmöbels

Beleuchtung

Der Schalter für die Beleuchtung des Kühlmöbels befindet sich oben rechts am Gerät.

Thermostat/Thermometer

Auf der unter rechten Seite des Kühlmöbels befindet sich ein Fernthermostat/Thermometer zur Temperaturkontrolle.

9.9 Reinigung und regelmäßige Wartung

Es wird empfohlen, im Arbeitsbereich für gute Lichtverhältnisse zu sorgen und eventuell eine zusätzliche Leuchtquelle einzuschalten.



Antibeslag-Beschichtung der LOW CONSUMPTION-Türen. Die Kühlmöbeltüren sind mit einer Antibeschlag-Beschichtung ausgestattet, die unabhängig von Luftfeuchtigkeit und Temperatur die Kondensatbildung verhindert. Dies gilt auch nach längerem Kontakt mit Wasser oder bei häufiger Reinigung. Die Beschichtung ist extrem wasserabweisend und erzeugt Wassertröpfchen, die sich verteilen und daher nicht in Kondensat verwandeln. Obwohl die Beschichtung Feuchtigkeit absorbiert, löst sie sich nicht in Wasser auf, sodass bei Nässe keine Flecken zurückbleiben. Handelsübliche Glasreiniger, Fleckenentferner, Ammoniak, Alkohol und Benzin schaden der Beschichtung nicht. Sie verfärbt sich auch nicht bei direkter Einwirkung von Sonne oder Hitze.

Die Türen werden mit einer Antibeschlag-Beschichtung geliefert, diese ist auf der Innenseite aufgebracht und wird durch eine Folie geschützt.

Diese Schutzfolie wurde an den Seiten bereits leicht gelöst, sodass sie sich vor der Inbetriebnahme einfach entfernen lässt. Die Schutzfolie darf erst nach dem Einsetzen der Türen in das Kühlmöbel entfernt werden und erst, nachdem das Gerät die richtige Betriebstemperatur erreicht hat. Dann setzt der Effekt der Antibeschlag-Beschichtung sofort ein.

Um an dieses korrekte Vorgehen zu erinnern ist auf der Schutzfolie der folgende Hinweis aufgedruckt: "DO NOT REMOVE THE PROTECTIVE FILM UNTIL THE CABINET HAS REACHED THE OPERATING TEMPERATURE".

Modello - Modèle - Model Modell - Modelo - Modelo	GRANSESIA	COSTAN eptarefrigeration
Fabbricante - Constructeur - Manufacturer Hersteller - Fabricante - Fabricante	Epta Spa - Via Mecenate, 86 - 20138 Milano (MI) ITALIA Tel. 02/55403211 Telefax 02/55401023	17/20

Die Reinigung des Kühlmöbels

Verwenden Sie für die Reinigung nur Wasser mit einer Temperatur von max. 65°C sowie milde Haushaltsseife oder ein in Wasser verdünntes, neutrales Reinigungsmittel.

Verwenden Sie bei den Glasflächen ausschließlich Produkte, die für die Reinigung von Glasflächen geeignet sind. Von einer Reinigung mit Wasser wird abgeraten, da sich sonst Kalkablagerungen auf der Glasflächen bilden können.

Verwenden Sie auf keinen Fall:

- Scheuerschwämme
- Entzündliche Produkte oder aggressive Mittel wie Alkohol, Azeton oder Lösungsmittel
- Reinigungsmittel, die nichtionische Tenside, Zitrone oder Essig (Essigsäure) enthalten



Waschen oder reinigen Sie den oberen Teil des Kühlmöbels nicht mit Wasser oder anderen Flüssigkeiten.

Reinigen Sie alle Außenflächen des Kühlmöbels **EINMAL PRO WOCHE**.

Reinigen Sie alle Innenflächen des Kühlmöbels **EINMAL PRO MONAT** und befolgen Sie dafür die folgende Anleitung:

- Trennen Sie das Kühlmöbel mit Hilfe des Wandschalters vom Stromnetz ("Abb. 24").
- Entleeren Sie das Kühlmöbel und lagern Sie die Waren in Kühlzellen oder Kühlschränken, in denen die Konservierungstemperatur aufrechterhalten wird.
- Warten Sie ab, bis das Kühlmöbel die Umgebungstemperatur erreicht hat und fahren Sie mit der Reinigung folgendermaßen fort
- Stellen Sie sicher, dass der Innenraum des Kühlmöbels auch wirklich vollständig trocken ist und schließen Sie es dann wieder an die Stromversorgung an.
- Warten Sie ein paar Stunden ab, bevor Sie die Waren zurück in das Kühlmöbel legen.

Wenn Sie das Gerät außer Betrieb setzen, trennen Sie es von der Stromversorgung und verfahren wie oben beschrieben. Lassen Sie anschließend die Türen offen stehen (falls vorhanden), um zu vermeiden, dass sich unangenehme Gerüche bilden.

Sie sollten das Kühlmöbel **ALLE DREI MONATE** abtauen, damit Eiskristalle, die sich möglicherweise auf den Lamellen des Verdampfers gebildet haben, schmelzen und seine Funktion nicht beeinträchtigen. Die Dauer und die Anzahl der Abtauvorgänge sind bereits werkseitig eingestellt. Änderungen dürfen nur durch den technischen Wartungsdienst vorgenommen werden. Das Abtauwasser fließt durch einen speziellen Ablauf. Überprüfen Sie regelmäßig, dass das Abtauwasser normal abläuft. Sollte das nicht der Fall sein, verwenden Sie eine stumpfe, flexible Sonde.



Abb. 27

1. Zu entfernen

Fahren Sie anschließend fort wie bei der **MONATLICHEN** Reinigung des Innenraums. Planen Sie aber eine entsprechend längere Wartezeit ein, da es dauern wird, bis das Eis komplett geschmolzen ist.

Modello - Modèle - Model Modell - Modelo - Modelo	GRANSESIA	COSTAN <small>eptarefrigeration</small>
Fabbricante - Constructeur - Manufacturer Hersteller - Fabricante - Fabricante	Epta Spa - Via Mecenate, 86 - 20138 Milano (MI) ITALIA Tel. 02/55403211 Telefax 02/55401023	18/20

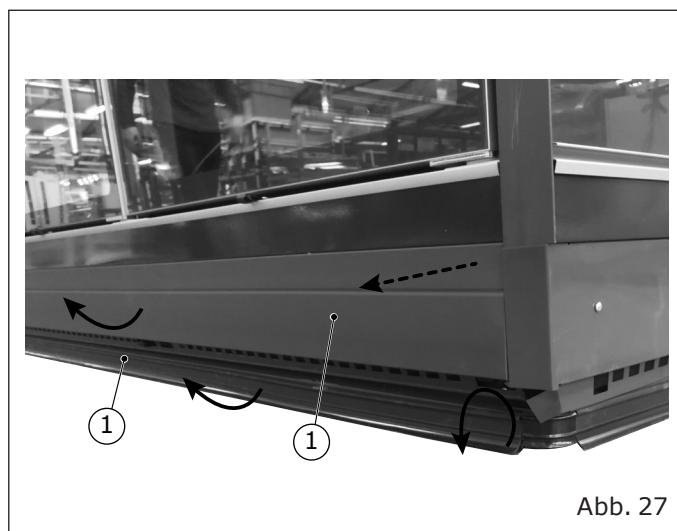
IT 9.10 Gefahrensituationen

FR Das Gerät geht nicht an oder stellt seinen Betrieb ein:

- EN • Stellen Sie sicher, ob nicht vielleicht ein allgemeiner Stromausfall die Ursache ist.
- DE • Überprüfen Sie, ob der Hauptschalter an der Wand eingeschaltet ist.
- ES • Kontrollieren Sie, ob der Netzstecker richtig eingesteckt ist.

PT Wenn keiner der vorgenannten Gründe die Ursache für die Stromunterbrechung ist, wenden Sie sich sofort an das nächstgelegene autorisierte Service-Center. Räumen Sie das Kühlmöbel schnellstmöglich leer und lagern Sie die Waren in Kühlzellen und Kühlschränken, in denen die korrekte Konservierungstemperatur herrscht.

Die Kühlleistung ist nicht ausreichend:

- Stellen Sie sicher dass das Kühlmöbel korrekt befüllt wurde.
- Falls in den letzten drei Monaten nicht geschehen, tauen Sie das Kühlmöbel ab und lassen Sie es anschließend seinen normalen Betrieb wiederaufnehmen.
- Überprüfen Sie, ob sich in der Nähe des Kühlmöbels eine Wärmequelle oder ein Luftzug befindet.
- Kontrollieren Sie die Umgebungsbedingungen, so wie sie im Abschnitt beschrieben sind: "Umgebungsbedingungen" ("Tab. II").
- Stellen Sie mit Hilfe einer Wasserwaage sicher, dass das Möbel gerade steht.

Sollte die Kühlleistung noch immer nicht ausreichend sein, wenden Sie sich an das nächste autorisierte Service-Center.

Das Kühlmöbel ist laut:

- Stellen Sie sicher, dass alle Schrauben und Muttern fest angezogen sind.
- Stellen Sie mit Hilfe einer Wasserwaage sicher, dass das Möbel gerade steht.

Sollte der Lärm andauern, wenden Sie sich an das nächste autorisierte Service-Center.

9.11 Technischer Wartungsdienst

Sollten Sie technische Hilfe benötigen, wenden Sie sich bitte umgehend an den Lieferanten, bei dem Sie das Gerät gekauft haben.

Sollten Sie Ersatzteile benötigen, wenden Sie sich immer an den technischen Kundendienst: Fragen Sie nach und vergewissern Sie sich, dass auch wirklich Originalersatzteile verwendet werden.

9.12 Demontage und Entsorgung

In Übereinstimmung mit den Entsorgungsvorschriften der einzelnen Länder und um unsere Umwelt zu schützen, bitten wir Sie, die einzelnen Komponenten des Geräts voneinander zu trennen, damit sie separat entsorgt oder ggf. ordnungsgemäß verwertet werden können.

Mit Ausnahme der Metallteile, die in den meisten europäischen Ländern nicht als Sondermüll eingestuft werden, sind die einzelnen Bauteile nicht wie Restmüll zu behandeln.



Das Kühlsystem arbeitet mit Hochdruck. Wenden Sie sich an qualifizierte Fachleute, bevor Sie das Gerät verschrotten.

Die zum Kühlkreislauf gehörigen Bauteile dürfen erst zerlegt und/oder abgetrennt werden, nachdem der Kühlkreislauf entleert wurde und das Kältegas durch qualifiziertes Personal aufgefangen wurde.

Modello - Modèle - Model Modell - Modelo - Modelo	GRANSESIA	COSTAN eptarefrigeration
Fabbricante - Constructeur - Manufacturer Hersteller - Fabricante - Fabricante	Epta Spa - Via Mecenate, 86 - 20138 Milano (MI) ITALIA Tel. 02/55403211 Telefax 02/55401023	19/20

10. ALLGEMEINE ERGÄNZENDE HINWEISE

Hinweise zur korrekten Installation und Wartung

Alle Hinweise zur Installation und Wartung finden Sie im Benutzerhandbuch auf der folgenden Webseite:

www.eptarefrigeration.com.

Die Installationsanleitungen für qualifiziertes Fachpersonal sind in an folgender Stelle verfügbar:

- beim Kundenservice.
- Im Lieferumfang einiger Produktkategorien ist die Installationsanleitung in Papierform enthalten.

Professioneller Reparaturservice

Dieses Angebot wird von unseren Servicestellen für Sie bereitgestellt, Sie finden die Informationen unter dem folgenden Link: www.eptarefrigeration.com.

Ersatzteile

Ersatzteile und Reparaturhinweise für das Gerät sind mindestens noch 8 Jahre, nachdem die Produktion eingestellt wurde, unter der folgenden Adresse verfügbar: www.epta-service.com/service.

Für die erforderlichen Zugangsdaten senden Sie bitte eine E-Mail an: servicesupport@eptarefrigeration.com.

Reinigung des luftgekühlten Kondensators

Damit sich die Leistung von Geräten mit integriertem Aggregat und luftgekühltem Kondensator nicht verschlechtert, muss der Kondensator gemäß der Vorgaben sowie in den vorgegebenen Zeitabständen gereinigt werden, wie im Installations- und Wartungshandbuch beschrieben.

Wichtiger Hinweis zur Lebensmittelverschwendung

Es wird empfohlen, die Lagerungshinweise auf den Produktverpackungen und die Anweisungen der Lebensmittelhersteller sorgfältig zu beachten.

Die Temperatureinstellungen müssen dabei gemäß den Angaben in unserer technischen Dokumentation an die Konservierungseigenschaften der Lebensmittel angepasst werden.

Unsachgemäßer Gebrauch kann zum vorzeitigen Verderb von Lebensmitteln führen.

Umgebungsbedingungen

Dieses Gerät ist für den Einsatz in einer Umgebung vorgesehen, in der die Temperatur und die Luftfeuchtigkeit innerhalb der in der Bedienungsanleitung angegebenen Bereiche liegen.

Anweisungen zur Demontage

Die Demontage muss durch qualifizierte Fachkräfte erfolgen.

Die Epta-Gruppe legt seit jeher großen Wert auf den Schutz der Umwelt. Sie stellt Ihnen die Anleitungen zur Demontage und Abfallbehandlung von steckerfertigen Kühlgeräten unter folgendem Link zum Herunterladen zur Verfügung.

- Handbuch zur Demontage offener Plugin-Modelle



- Handbuch zur Demontage geschlossener Plugin-Modelle:



Weitere Informationen

Bitte wenden Sie sich für nähere Informationen an die folgende Adresse www.eptarefrigeration.com und an sie Produktdatenbank EPREL. Sie können diese Seite aufrufen, indem Sie den QR-Code auf dem Energielabel Ihres Geräts scannen.



Modello - Modèle - Model Modell - Modelo - Modelo	GRANSESIA	COSTAN <small>eptarefrigeration</small>
Fabbricante - Constructeur - Manufacturer Hersteller - Fabricante - Fabricante	Epta Spa - Via Mecenate, 86 - 20138 Milano (MI) ITALIA Tel. 02/55403211 Telefax 02/55401023	20/20

IT

Grenzen der vorgesehenen Anwendung

FR



Dieses Gerät ist für den Einsatz, den Transport und die Lagerung bis zu einer maximalen Höhe von 2000 m über dem Meeresspiegel ausgelegt.

EN

DE

Lagerung:

- Temperatur zwischen 15°C und 50°C.
- Relative Luftfeuchtigkeit zwischen 20% und 90%.
- Maximal für 6 Monate.

ES

PT

Transport:

- Temperatur zwischen 20°C und 70°C.
- Relative Luftfeuchtigkeit zwischen 20% e 90%.
- Maximal für 2 Monate.

Installation:

- Temperatur zwischen 0°C und 40°C.
- Relative Luftfeuchtigkeit zwischen 20% und 90%.
- Maximal für 2 Monate.

Verwendung:

Die Leistung des Geräts kann bei einem anderen als dafür vorgesehenen Einsatz nicht gewährleistet werden.

Innerhalb der folgenden Grenzen kann seine Zuverlässigkeit und Sicherheit vorübergehend gewährleistet werden.

Temperatur außerhalb des Kühlmöbels:

- Von Klasse # 1 (16°C / 80%rh) bis Klasse 4 (30°C / 55%rh) oder Klasse 6 (27°C / 70%rh).

Bedingungen im Inneren des Kühlmöbels (für die elektrische Sicherheit):

Gerät mit Normalkühlung

- Temperatur zwischen -10°C und +10°C.
- Relative Luftfeuchtigkeit zwischen 70% und 100%.
- Maximal 10 Jahre.

Gerät mit Tiefkühlung

- Temperatur zwischen -40°C und 15°C.
- Relative Luftfeuchtigkeit zwischen 90% und 100%.
- Maximal 10 Jahre.



Wenn die Heizelemente in Betrieb sind, können die oben genannten Grenzwerte in einigen Bereichen des Geräts überschritten werden. Die Sicherheitsbestimmungen werden dabei aber trotzdem eingehalten.

Modello - Modèle - Model Modell - Modelo - Modelo	GRANSESIA	COSTAN <small>eptarefrigeration</small>
Fabbricante - Constructeur - Manufacturer Hersteller - Fabricante - Fabricante	Epta Spa - Via Mecenate, 86 - 20138 Milano (MI) ITALIA Tel. 02/55403211 Telefax 02/55401023	1/20

ÍNDICE

1.	Introducción	2
2.	Advertencias de seguridad	3
2.1	Advertencias generales	3
2.2	Advertencias para el mantenimiento del mueble	4
2.3	Advertencias eléctricas	5
2.4	Prohibiciones	5
3.	Descripción general	6
3.1	Secciones	6
4.	Transporte del mueble	7
5.	Condiciones ambientales	8
6.	Características técnicas	9
7.	Uso del mueble	10
8.	Mantenimiento ordinario	13
8.1	Limpieza del mueble	13
9.	Instrucciones para el usuario	14
9.1	Descripción del mueble	14
9.2	Transporte y manipulación	14
9.3	Recepción y almacenamiento	14
9.4	Instalación y condiciones ambientales	15
9.5	Conexión eléctrica	15
9.6	Características técnicas	15
9.7	Carga del producto	15
9.8	Uso del mueble	16
9.9	Limpieza y mantenimiento de rutina	16
9.10	Situaciones de emergencia	18
9.11	Asistencia técnica	18
9.12	Desmantelamiento y eliminación	18
10.	Advertencias generales adicionales	19

SÍMBOLOS UTILIZADOS



Símbolo de prohibición: se prohíbe realizar determinadas operaciones.



Símbolo de atención: normas de prevención de accidentes para el operador.



Símbolo de advertencia: posibilidad de dañar el mueble y/o sus componentes.



Símbolo de nota: proporciona información útil.

Modello - Modèle - Model Modell - Modelo - Modelo	GRANSESIA	COSTAN eptarefrigeration
Fabbricante - Constructeur - Manufacturer Hersteller - Fabricante - Fabricante	Epta Spa - Via Mecenate, 86 - 20138 Milano (MI) ITALIA Tel. 02/55403211 Telefax 02/55401023	2/20

IT

1. INTRODUCCIÓN

FR

Se recomienda leer atentamente el contenido de este manual y guardarlo junto con el mueble. El fabricante declina toda responsabilidad por los daños causados a las personas o a los bienes debido al incumplimiento de las advertencias contenidas en este manual.

EN

DE

ES

PT



Este manual contiene la información que se considera necesaria para el buen uso y funcionamiento del mueble.

Contiene las siguientes descripciones e información:

- una descripción funcional del mueble y de cada una de sus partes
- información sobre la seguridad del mueble y las normas de prevención de accidentes que se deben respetar
- uso correcto del mueble
- un correcto mantenimiento rutinario y programado, incluidas las operaciones de limpieza

Información no contenida en este manual:

- Instrucciones de instalación

Para la correcta instalación del mueble, consultar los siguientes documentos:

- Manual técnico
- Instrucciones de referencia rápida

Este manual está dirigido a los siguientes profesionales:

- **OPERADOR CUALIFICADO:** persona cualificada, capacitada en el funcionamiento, ajuste, limpieza y mantenimiento de rutina del mueble
- **TÉCNICO ESPECIALIZADO:** técnico capacitado y autorizado por el organismo indicado en el contrato (fabricante/concesionario/distribuidor) para realizar la instalación, el mantenimiento extraordinario, la reparación, la sustitución y la revisión del mueble

Las instrucciones de uso también están disponibles en:

www.eptarefrigeration.com.

Consultar la declaración de conformidad para conocer las normas y certificaciones del mueble.

Conserve siempre el manual de instrucciones y en caso de venta.

Modello - Modèle - Model Modell - Modelo - Modelo	GRANSESIA	COSTAN <small>eptarefrigeration</small>
Fabbricante - Constructeur - Manufacturer Hersteller - Fabricante - Fabricante	Epta Spa - Via Mecenate, 86 - 20138 Milano (MI) ITALIA Tel. 02/55403211 Telefax 02/55401023	3/20

2. ADVERTENCIAS DE SEGURIDAD

2.1 Advertencias generales



El fabricante declina toda responsabilidad por los daños causados a las personas o a los bienes debido al incumplimiento de las advertencias contenidas en este manual. Toda persona que utilice el mueble debe leer este manual de uso.



El empresario debe instruir al personal sobre los riesgos de accidentes, los dispositivos previstos para la seguridad del personal, los riesgos de emisión de ruidos y las normas generales de prevención de accidentes previstas por la normativa vigente.



El mueble debe ser utilizado por personas adultas que posean los conocimientos necesarios y cuyas capacidades físicas, sensoriales o mentales no estén reducidas. El mueble no está destinado a ser utilizado por menores (especialmente de 0 a 3 años). De todas formas, los niños vigilados por adultos y bajo su responsabilidad no deben jugar con el mueble.



Cualquier otro uso no indicado explícitamente en este manual debe considerarse peligroso y el fabricante no se hace responsable de los daños derivados de un uso inadecuado, incorrecto o no razonable.



El mueble debe ser utilizado por personal que dispone del equipo de protección personal adecuado.



El uso de guantes de trabajo es obligatorio.



No dejar el mueble expuesto a la intemperie.



No utilizar chorros de agua directos o indirectos sobre el mueble.



No tocar el mueble con las manos o los pies mojados o húmedos, no usarlo con los pies descalzos.



El desmontaje de los resguardos o paneles que requieran el uso de herramientas para retirarlos está reservado exclusivamente al personal cualificado.



Para la instalación de accesorios opcionales dedicados, contactar con el centro de asistencia autorizado más cercano.



Todos los trabajos deben ser realizados únicamente por personal cualificado y, en cualquier caso, se debe desconectar la alimentación eléctrica del mueble antes de realizar cualquier operación.

IT

FR

EN

DE

ES

PT

Modello - Modèle - Model Modell - Modelo - Modelo	GRANSESIA	COSTAN <small>eptarefrigeration</small>
Fabbricante - Constructeur - Manufacturer Hersteller - Fabricante - Fabricante	Epta Spa - Via Mecenate, 86 - 20138 Milano (MI) ITALIA Tel. 02/55403211 Telefax 02/55401023	4/20

IT
FR
EN
DE
ES
PT

 Instruir a cualquier persona que utilice el mueble sobre la posición del interruptor seccionador.

 El ajuste del termostato se le reserva al personal técnico de asistencia.

 Prestar atención a las partes calientes o móviles marcadas con el símbolo correspondiente.

 En caso de incendio, no utilizar agua para extinguir las llamas, sino sólo extintores de polvo seco.

 No dañar el circuito refrigerante.

 Evitar la presencia de fuegos o chispas en el interior del aparato.

 Dejar libres las aberturas de ventilación de la carcasa del aparato y no obstruirlas.

 No utilizar aparatos eléctricos dentro de los compartimentos del mueble para el almacenamiento de alimentos congelados si no son del tipo recomendado por el fabricante.

 No conservar en este mueble sustancias explosivas o peligrosas, como recipientes a presión con gas propelente inflamable.

 No apoyar objetos sobre la parte superior del mueble; Es oportuno evitar que los productos no embalados se apoyen directamente sobre los estantes, sino que es preferible utilizar contenedores apropiados para alimentos.

 No coloque recipientes para líquidos y no vierta líquidos sobre la encimera.

2.2 Advertencias para el mantenimiento del mueble

 El acceso a las partes eléctricas y/o a las partes que requieren el uso de herramientas está reservado a los técnicos especializados.

 Antes de realizar cualquier operación de mantenimiento y limpieza reservada al usuario, desconectar la alimentación del mueble mediante el interruptor seccionador instalado en la pared.

 Prestar atención a las partes calientes o móviles marcadas con el símbolo correspondiente.

 El uso de guantes de trabajo es obligatorio.

Modello - Modèle - Model Modell - Modelo - Modelo	GRANSESIA	COSTAN <small>eptarefrigeration</small>
Fabbricante - Constructeur - Manufacturer Hersteller - Fabricante - Fabricante	Epta Spa - Via Mecenate, 86 - 20138 Milano (MI) ITALIA Tel. 02/55403211 Telefax 02/55401023	5/20

2.3 Advertencias eléctricas



Asegurarse de que la tensión de alimentación coincida con los datos de la placa de características del mueble.



La instalación eléctrica debe ser realizada por técnicos especializados.



El desmontaje de la tapa del cuadro eléctrico está reservado a los técnicos especializados.



De acuerdo con las normas de instalación, la red de alimentación debe incluir un dispositivo de desconexión omnipolar que garantice la desconexión completa de la red en condiciones de categoría de sobretensión III.



La instalación del mueble debe realizarse siguiendo las instrucciones del fabricante, por personal profesionalmente cualificado y de conformidad con la normativa de instalación eléctrica vigente en cada país.



Una instalación incorrecta del mueble puede causar daños a personas, animales o bienes, de los que el fabricante no se hace responsable.



Si el cable de alimentación está dañado, debe ser reemplazado por personal de servicio autorizado. No intente reparar el cable.



No encienda el banco si está dañado. En caso de duda, póngase en contacto con el servicio posventa o con su distribuidor.

2.4 Prohibiciones



Está prohibido utilizar dispositivos distintos a los suministrados en el mueble por el fabricante para acelerar el proceso de deshielo.



Está prohibido que el personal no especializado retire la tapa del cuadro eléctrico o abra los paneles que requieran el uso de herramientas.



Está prohibido utilizar el mueble para almacenar y/o exponer sustancias explosivas, inflamables o corrosivas, como aerosoles espray con gas propelente inflamable.



Está prohibido utilizar el mueble para almacenar y/o exponer productos farmacéuticos.



En el caso de PRODUCTOS SIN ENVASAR O ALMACENADOS A BAJA TEMPERATURA, está prohibido utilizar el mueble para el almacenamiento y/o exposición de botellas y envases de vidrio.



Está prohibido colocar el mueble en locales con presencia de sustancias gaseosas explosivas.



Está prohibido quitar la placa de identificación del mueble.



Está prohibido subirse al mostrador o al parachoques del mostrador.

IT

FR

EN

DE

ES

PT

Modello - Modèle - Model Modell - Modelo - Modelo	GRANSESIA	COSTAN eptarefrigeration
Fabbricante - Constructeur - Manufacturer Hersteller - Fabricante - Fabricante	Epta Spa - Via Mecenate, 86 - 20138 Milano (MI) ITALIA Tel. 02/55403211 Telefax 02/55401023	6/20

3. DESCRIPCIÓN GENERAL

3.1 Secciones

COMPACT

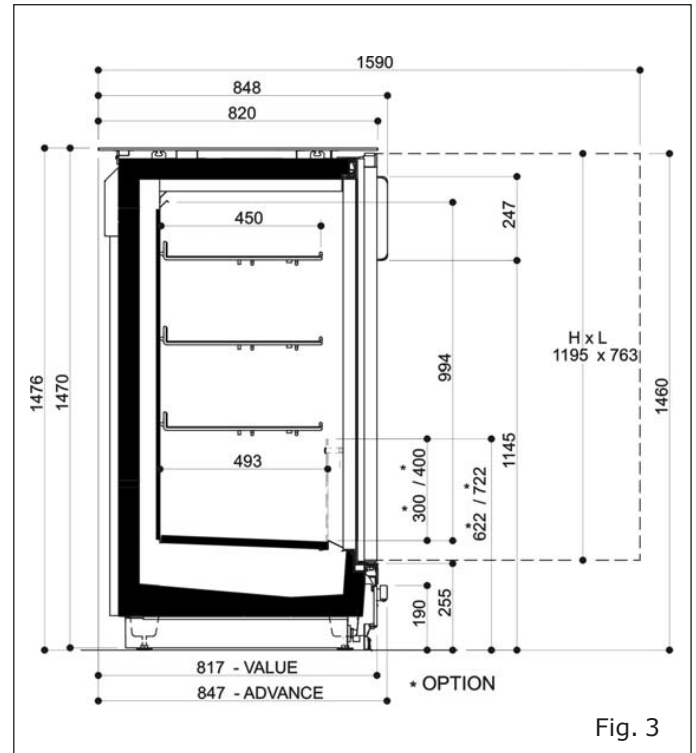

Fig. 3

NARROW

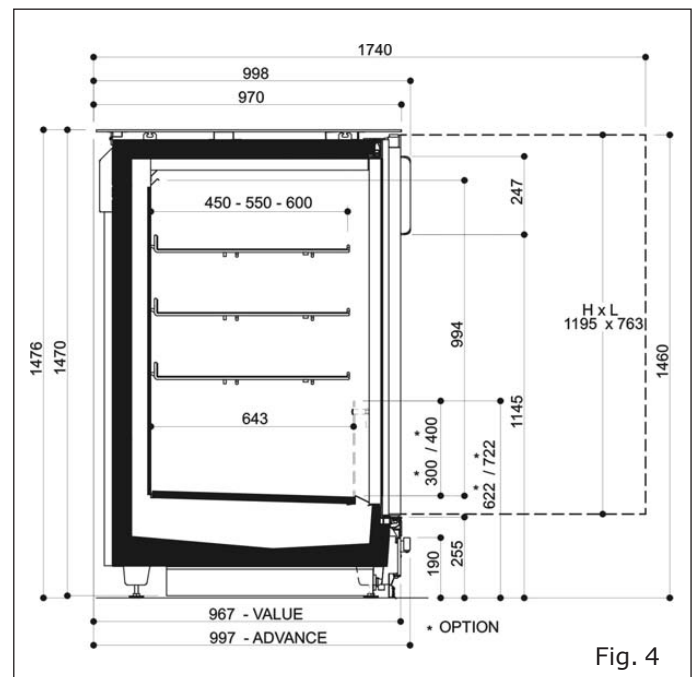

Fig. 4



Fig. 2

1. Placa de datos
2. Interruptor luces
3. Iluminación
4. Barandilla parachoques (opcional)
5. Termostato remoto

Modello - Modèle - Model Modell - Modelo - Modelo	GRANSESIA	COSTAN eptarefrigeration
Fabbricante - Constructeur - Manufacturer Hersteller - Fabricante - Fabricante	Epta Spa - Via Mecenate, 86 - 20138 Milano (MI) ITALIA Tel. 02/55403211 Telefax 02/55401023	7/20

4. TRANSPORTE DEL MUEBLE



1. Puntos de elevación

Tabla I

Modelo		Peso (kg)	Peso con embalaje (kg)
2D	COMPACT	350	490
3D		500	550
2D EOL		350	490
2D	NARROW	350	490
3D		500	550
EOL 3D-S		500	550

Modello - Modèle - Model Modell - Modelo - Modelo	GRANSESIA	COSTAN eptarefrigeration
Fabbricante - Constructeur - Manufacturer Hersteller - Fabricante - Fabricante	Epta Spa - Via Mecenate, 86 - 20138 Milano (MI) ITALIA Tel. 02/55403211 Telefax 02/55401023	8/20

IT
FR
EN
DE
ES
PT

5. CONDICIONES AMBIENTALES



Fig. 7



Fig. 9

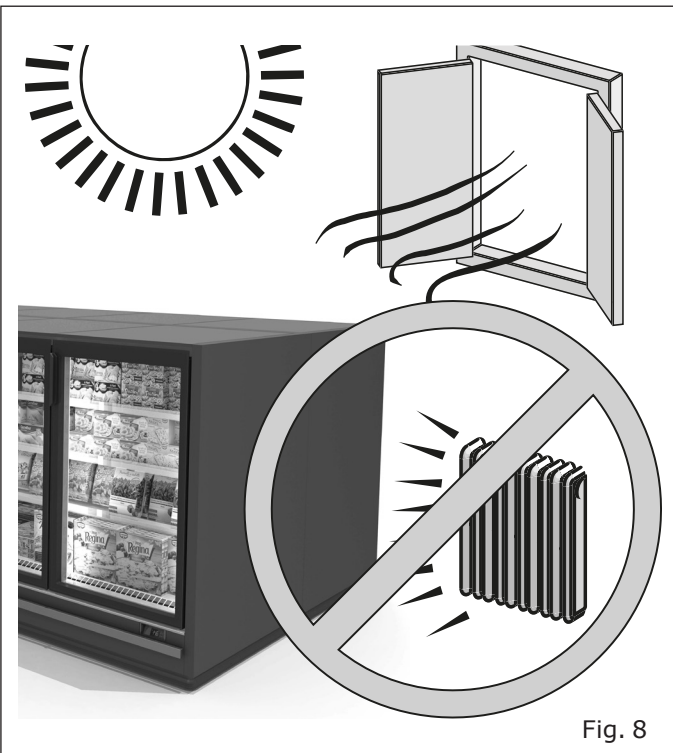

Fig. 8

Tabla II

Características	
Tipo de local	Cerrado
Temperatura	25°C
Humedad relativa	60 %
Iluminación	600 lx

Modello - Modèle - Model Modell - Modelo - Modelo	GRANSESIA	COSTAN eptarefrigeration
Fabbricante - Constructeur - Manufacturer Hersteller - Fabricante - Fabricante	Epta Spa - Via Mecenate, 86 - 20138 Milano (MI) ITALIA Tel. 02/55403211 Telefax 02/55401023	9/20

6. CARACTERÍSTICAS TÉCNICAS







 <small>EPTA S.p.A. Via Mecenate, 86 20138 Milano - Italy</small>		12
1	2	SN 13  14 REF 15 16
RATED BEMESSUNG ASSIGNÉ NOMINALE NOMINAL 3 4 5 6		REFRIGERANT KÄLTEMITTEL RÉFRIGÉRANT REFRIGERANTE REFRIGERANTE 17 18 19 20
DEFROSTING ABTAUUNG DÉGIVRAGE SBRINAMENTO DESCONGELAMIENTO 7 8		CLIMATIC CLASS KLIMAKLASSE CLASSE CLIMATICA CLASSE CLIMATICA CLASE CLIMÁTICA 21
HEATING SYSTEMS HEIZUNGSSYSTEME SYSTEMES CHAUFFANTS SISTEMI DI RISCALDAMENTO SISTEMA DE CALEFACCIÓN 9		INSULATION BLOWING GAS ISOLATIONSGAS (BLÄHGAS) AGENT MOUSSANT D' ISOLATION GAS ESPUMANTE ISOLAMENTO AGENTE ESPUMANTE 22
 10		PROTECTION INDEX SCHUTZART INDEX DE LA PROTECTION INDICE DI PROTEZIONE ÍNDICE DE PROTECCIÓN 23
 <small>Read Operator's Manual available at www.eptarefrigeration.com or calling +39 0437 968379</small> 11		24  

Fig. 10

- | | |
|--|--|
| <ul style="list-style-type: none"> 1. Origen del producto 2. Fabricado en «País de origen» 3. Tensión nominal 4. Potencia nominal 5. Frecuencia nominal 6. Corriente nominal 7. Potencia de deshielo 8. Corriente de deshielo 9. Sistema de calentamiento 10. Sistema de iluminación 11. Manual del operador 12. Código de barras 13. Número de serie | <ul style="list-style-type: none"> 14. Fecha de producción 15. Código Hat 16. Modelo 17. Tipo de refrigerante 1 18. Masa refrigerante 1 19. Tipo de refrigerante 2 20. Masa refrigerante 2 21. Clase climática 22. Aislamiento gas 23. Índice de protección 24. Marcas de certificación 25. Marca RAEE |
|--|--|





El uso de separadores internos entre los estantes y en la base es obligatorio para garantizar el buen funcionamiento del mueble. En la versión de 3 puertas, los separadores se suministran de serie.

Modello - Modèle - Model Modell - Modelo - Modelo	<h1>GRANSESIA</h1>	
Fabbricante - Constructeur - Manufacturer Hersteller - Fabricante - Fabricante	Epta Spa - Via Mecenate, 86 - 20138 Milano (MI) ITALIA Tel. 02/55403211 Telefax 02/55401023	10/20

IT
FR
EN
DE
ES
PT

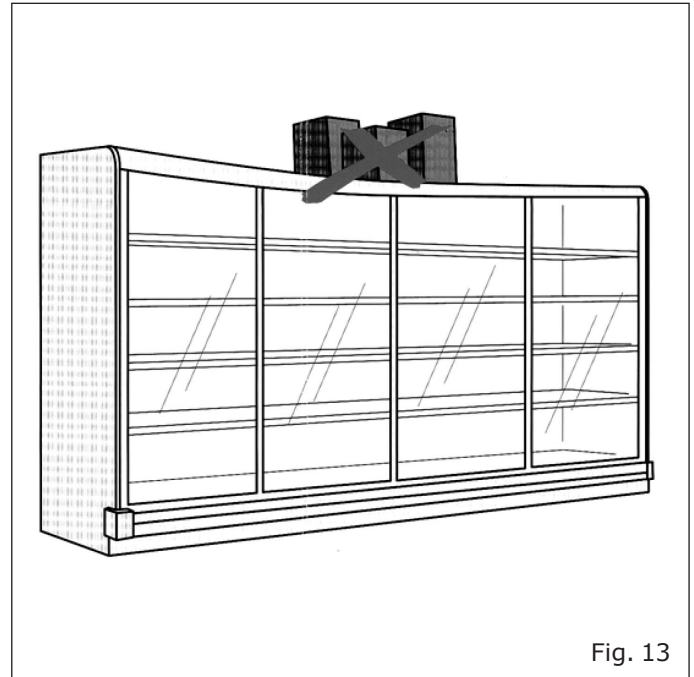
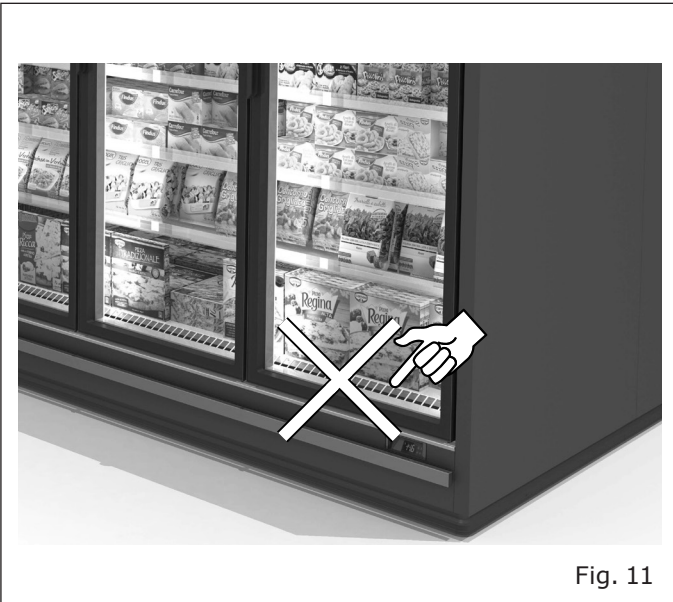
7. USO DEL MUEBLE



 No cubrir

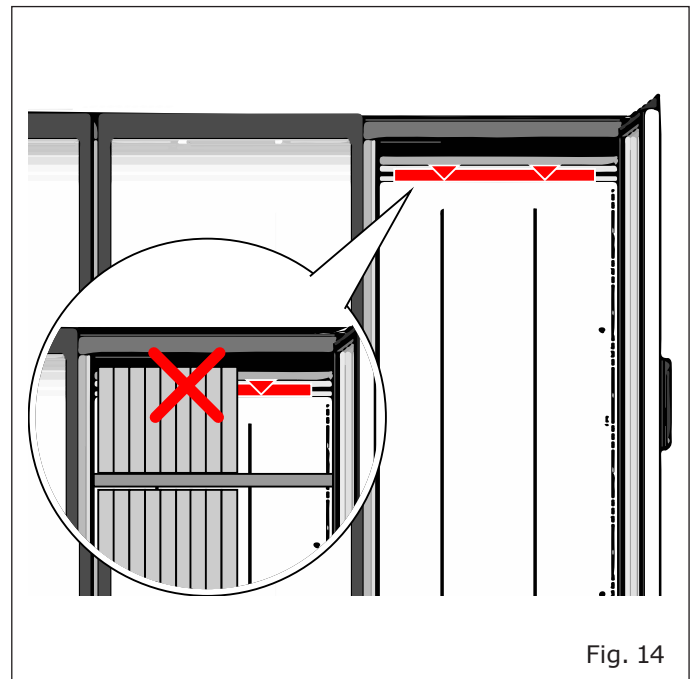

 Respetar la línea de carga

Modello - Modèle - Model Modell - Modelo - Modelo	<h1>GRANSESIA</h1>	
Fabbricante - Constructeur - Manufacturer Hersteller - Fabricante - Fabricante	Epta Spa - Via Mecenate, 86 - 20138 Milano (MI) ITALIA Tel. 02/55403211 Telefax 02/55401023	11/20

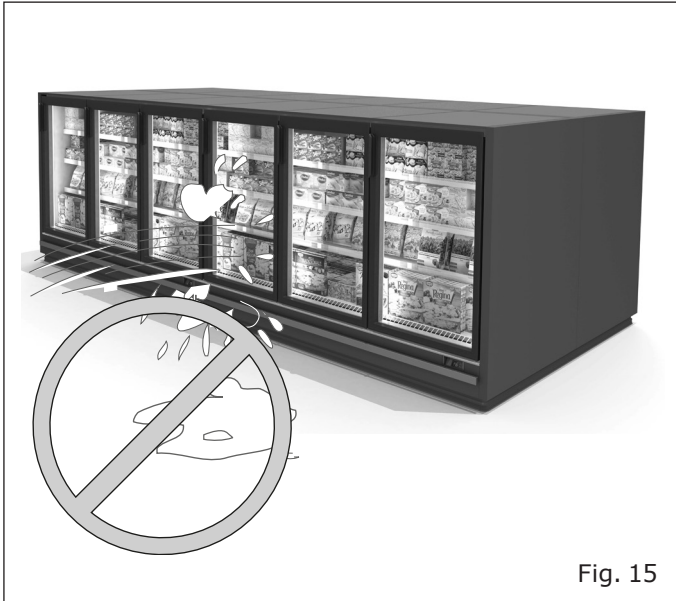

Fig. 15

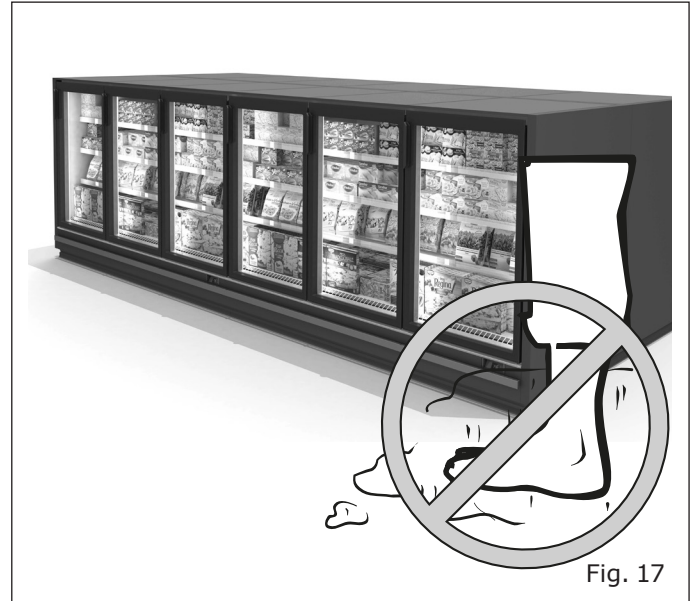

Fig. 17

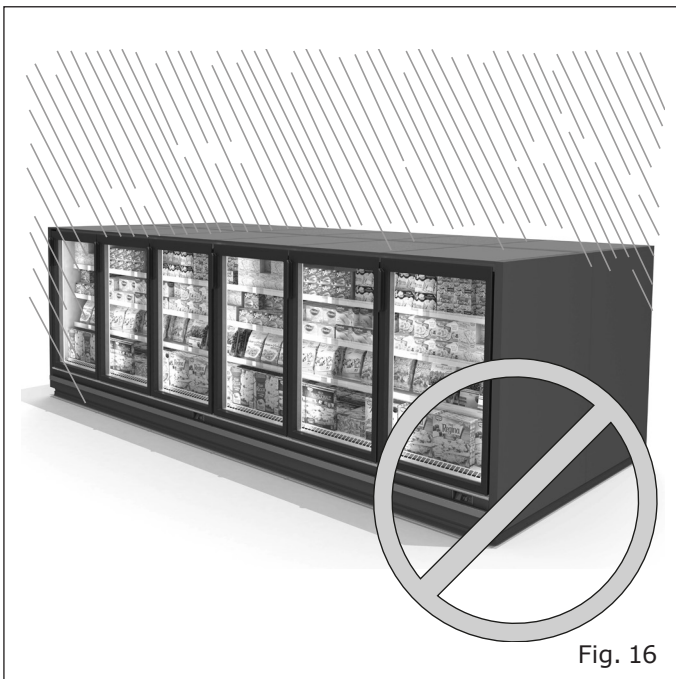

Fig. 16

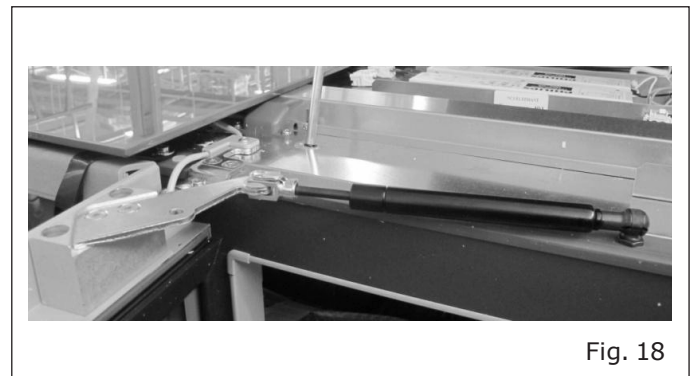

Fig. 18



Fig. 19

- IT
- FR
- EN
- DE
- ES
- PT

Modello - Modèle - Model Modell - Modelo - Modelo	<h1>GRANSESIA</h1>	
Fabbricante - Constructeur - Manufacturer Hersteller - Fabricante - Fabricante	Epta Spa - Via Mecenate, 86 - 20138 Milano (MI) ITALIA Tel. 02/55403211 Telefax 02/55401023	12/20

IT
FR
EN
DE
ES
PT



Fig. 20

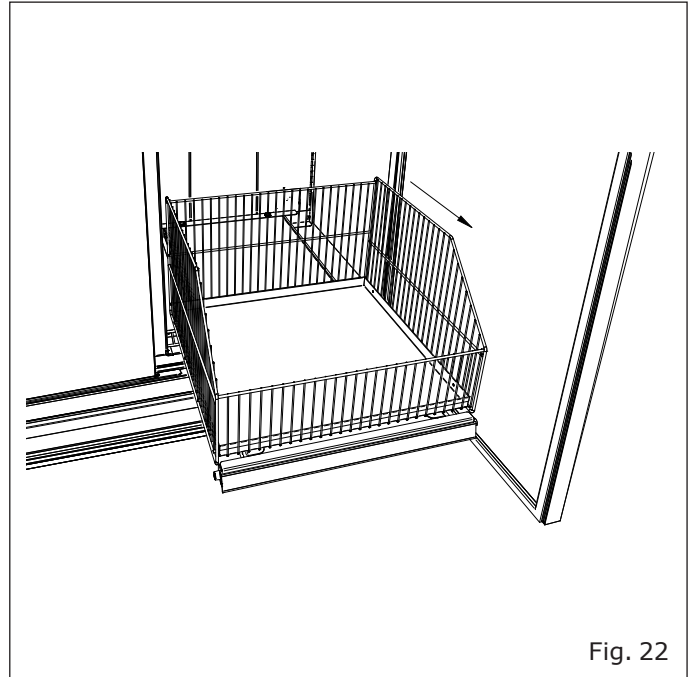

Fig. 22



Fig. 21

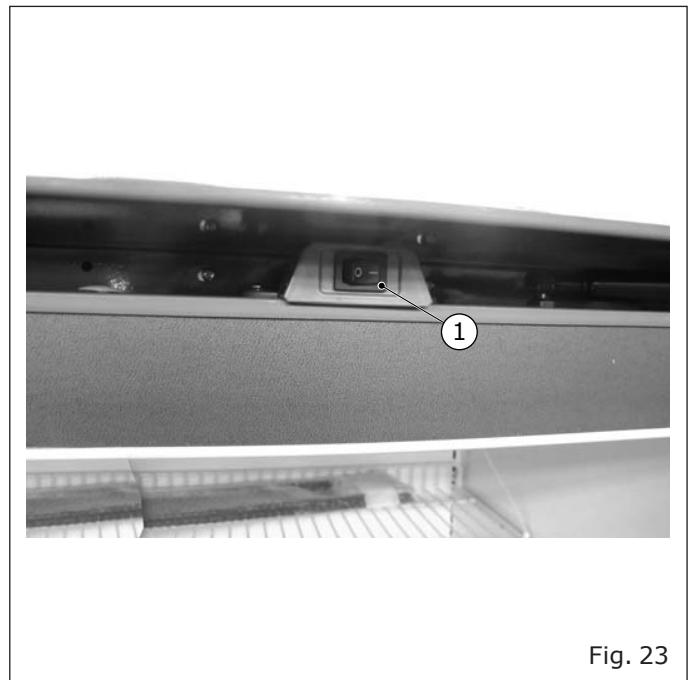

Fig. 23

1. Interruptor iluminación

Modello - Modèle - Model Modell - Modelo - Modelo	GRANSESIA	
Fabbricante - Constructeur - Manufacturer Hersteller - Fabricante - Fabricante	Epta Spa - Via Mecenate, 86 - 20138 Milano (MI) ITALIA Tel. 02/55403211 Telefax 02/55401023	13/20

8. MANTENIMIENTO ORDINARIO

8.1 Limpieza del mueble

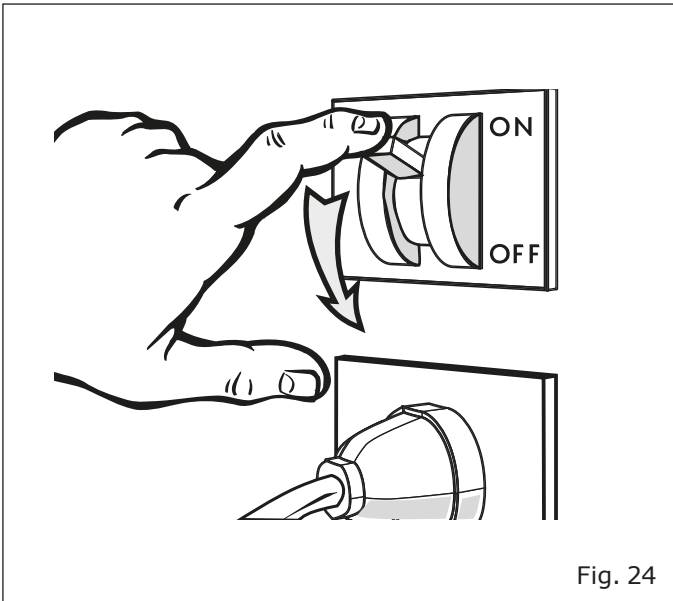

Fig. 24



Fig. 25

Modello - Modèle - Model Modell - Modelo - Modelo	GRANSESIA	COSTAN eptarefrigeration
Fabbricante - Constructeur - Manufacturer Hersteller - Fabricante - Fabricante	Epta Spa - Via Mecenate, 86 - 20138 Milano (MI) ITALIA Tel. 02/55403211 Telefax 02/55401023	14/20

9. INSTRUCCIONES PARA EL USUARIO

9.1 Descripción del mueble

Esta línea de muebles es adecuada para almacenar y exponer helados y alimentos congelados.

CLASE DE TEMPERATURA (según EN ISO 23953-2): 3L1.

Las características generales y las dimensiones se ilustran en las figuras y secciones contenidas en la "Descripción general" (a pág. "7").

Durante las operaciones de transporte y manipulación, recepción y almacenamiento, instalación, carga, uso, limpieza y mantenimiento, y desmontaje, tener en cuenta el riesgo de vuelco del mueble ("Fig. 26").

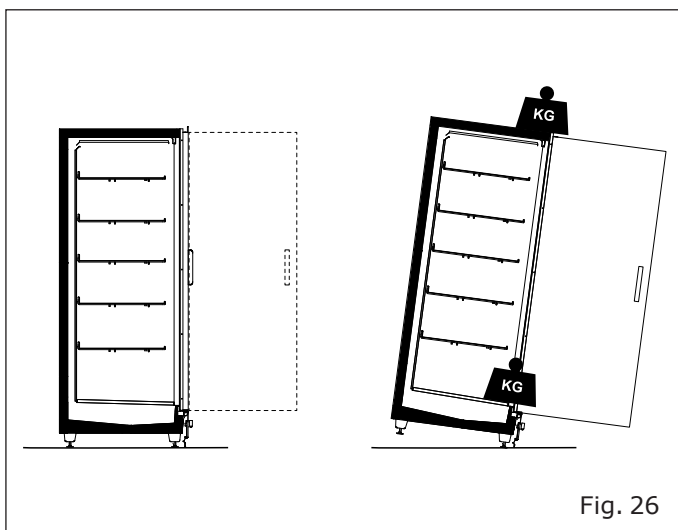

Fig. 26

9.2 Transporte y manipulación

El mueble está contenido en un embalaje especial equipado con una plataforma para su manipulación con carretillas elevadoras.

Para transportar y manipular el mueble utilizar:

- Sólo una plataforma adecuada o equivalente
- Una carretilla elevadora manual o eléctrica adecuada para la elevación del mueble, con las características apropiadas de acuerdo con las normas vigentes

El peso del mueble (vacío y con embalaje) y las dimensiones del embalaje se indican en "Transporte del mueble" (tabla "Tabla I" y las figuras en la página "8").

Las operaciones de manipulación deben ser realizadas por personal cualificado, capaz de evaluar los pesos, los puntos de elevación y los medios más adecuados, desde el punto de vista de la seguridad y la capacidad.

9.3 Recepción y almacenamiento

Comprobar el estado del embalaje antes de retirar el mueble del transportista.

Si hay daños evidentes en el embalaje:

- Retirar el embalaje del mueble en presencia del transportista.
- Firmar el albarán con reserva.

El fabricante no se hace responsable de los daños causados por el transporte o del almacenamiento inadecuado del mueble.

El mueble debe almacenarse en un lugar protegido del sol y de la intemperie, con una temperatura entre -25°C y +55°C y una humedad relativa del aire comprendida entre 30% y 95%.

Modello - Modèle - Model Modell - Modelo - Modelo	GRANSESIA	COSTAN eptarefrigeration
Fabbricante - Constructeur - Manufacturer Hersteller - Fabricante - Fabricante	Epta Spa - Via Mecenate, 86 - 20138 Milano (MI) ITALIA Tel. 02/55403211 Telefax 02/55401023	15/20

9.4 Instalación y condiciones ambientales

El mueble no está diseñado para ser instalado en el exterior.

Para un buen funcionamiento del mueble, comprobar que esté colocado:

- Sobre un suelo nivelado ("Fig. 7").
- Lejos de fuentes de calor, luz solar directa, puertas, ventanas, ventiladores y rejillas de ventilación ("Fig. 8").

Asegurarse de que haya suficiente espacio para que los clientes utilicen el mueble.

Las condiciones del entorno en el que se va a colocar el mueble se indican en "Condiciones ambientales".

9.5 Conexión eléctrica

Debe instalarse un interruptor seccionador omnipolar antes del mueble. Debe tener:

- Distancia mínima de los contactos de 3 mm.
- Poder de interrupción adecuado

El interruptor seccionador debe colocarse en una posición en la que pueda ser fácilmente operado en situaciones de emergencia (distancia máxima de 3 m).

Antes de conectar el mueble, asegurarse de que la tensión de alimentación sea la indicada en los datos de la placa de características del mueble. Para garantizar un funcionamiento regular, la variación máxima de la tensión debe estar comprendida entre +/- 6% del valor nominal.

9.6 Características técnicas

La placa de características muestra los datos técnicos distintivos del mueble. Su ubicación y el tipo de datos se indican en "Características técnicas" ("Fig. 10").

Los diagramas eléctricos, las listas de calibración de los instrumentos de control, las instrucciones de instalación y una copia de la Declaración de Conformidad están disponibles en el sitio <https://documents.eptarefrigeration.com>.

El nivel de presión sonora generado por el funcionamiento del mueble es inferior a 70 dB(A). El mueble no provoca vibraciones perjudiciales.

9.7 Carga del producto

Dar tensión al mueble para iniciar su ciclo de enfriamiento, utilizando el interruptor seccionador general instalado en la pared. Después de unas 2 horas se puede cargar el mueble.

El mueble está diseñado para mantener la temperatura de la mercancía y no para bajarla; por lo tanto, los alimentos deben colocarse en el mueble solo si ya están enfriados a sus respectivas temperaturas de almacenamiento. Los productos que se han calentado nunca deben colocarse en el mueble.

Si el mueble tiene vidrios en la parte delantera, es aconsejable cargar la mercancía cuando no hay clientes en el espacio de venta.

Al cargar las mercancías, asegurarse de que:

- La carga sea homogénea en cuanto a tamaño y calidad de las mercancías
- La mercancía no obstruya el correcto flujo de aire refrigerado ("Fig. 11").
- La mercancía no sobrepase la línea de carga ("Fig. 14").

La carga máxima admisible esté distribuida uniformemente:

- En los estantes: 160 kg/m²
- En el plano de fondo: 225 kg/m²

Modello - Modèle - Model Modell - Modelo - Modelo	GRANSESIA	COSTAN <small>eptarefrigeration</small>
Fabbricante - Constructeur - Manufacturer Hersteller - Fabricante - Fabricante	Epta Spa - Via Mecenate, 86 - 20138 Milano (MI) ITALIA Tel. 02/55403211 Telefax 02/55401023	16/20

IT
FR
EN
DE
ES
PT



La puerta ha sido diseñada para quedar abierta SIN NINGÚN SISTEMA DE BLOQUEO MECÁNICO, simplemente abriéndola a 90°. Además, el sistema de «cierre suave» garantiza un cierre automático lento y suave en la parte final, sin necesidad de forzarlo. Por esta razón NO ES NECESARIO ABRIR la puerta más allá de 90° y bloquearla con pesos o MANTENERLA en posición si ya está abierta a 90° ("Fig. 19, "Fig. 21").



Durante la carga, si hay cestas deslizantes (opcional), no deben sacarse todas al mismo tiempo ("Fig. 22").

9.8 Uso del mueble

Iluminación

La iluminación del mueble es accionada por un interruptor situado en la parte superior derecha del mueble.

Termostato/termómetro

En la parte abajo derecha del mueble hay un termostato/termómetro remoto para controlar la temperatura.

9.9 Limpieza y mantenimiento de rutina

Se recomienda mantener una buena visibilidad en la zona de intervención, usando una fuente de iluminación ulterior si fuera necesario.



Revestimiento antivaho de las puertas de BAJO CONSUMO. Las puertas del mueble tienen un revestimiento antivaho que evita que se empañen en todas las condiciones de temperatura y humedad, incluso después de inmersiones prolongadas en agua o limpiezas frecuentes. Extremadamente hidrófilo, el revestimiento produce gotas de agua que se propagan y no se transforman y, por tanto, no empañan. Aunque el revestimiento absorbe la humedad, no se disuelve en el agua y, por consiguiente, no se mancha cuando se moja. La película no se daña con los productos limpiacristales comerciales, los quitamanchas, el amoníaco, el alcohol y la gasolina, y no se decolora cuando se expone a la luz solar o al calor.

Las puertas se suministran con el revestimiento antivaho laminado en el cristal interior y protegido por una capa.

La capa protectora está parcialmente levantada en los lados para facilitar su retirada durante el uso. La retirada de la capa protectora debe realizarse después de la instalación de las puertas en el mueble, una vez que éste haya alcanzado la temperatura de uso, para permitir que la película antivaho actúe inmediatamente. Para recordar este paso, se coloca la siguiente etiqueta en la lámina protectora: «NO QUITAR LA PELÍCULA PROTECTORA HASTA QUE EL MUEBLE NO HAYA ALCANZADO LA TEMPERATURA DE FUNCIONAMIENTO».

Modello - Modèle - Model Modell - Modelo - Modelo	GRANSESIA	COSTAN eptarefrigeration
Fabbricante - Constructeur - Manufacturer Hersteller - Fabricante - Fabricante	Epta Spa - Via Mecenate, 86 - 20138 Milano (MI) ITALIA Tel. 02/55403211 Telefax 02/55401023	17/20

Limpieza del mueble

Utilizar únicamente agua a una temperatura máxima de 65°C y jabón o detergente doméstico neutro diluido en agua.

Para superficies acristaladas utilizar sólo productos de limpieza de vidrios. Se recomienda evitar el uso de agua, ya que puede depositar sedimentos calcáreos sobre la superficie del vidrio.

Por ningún motivo usar:

- Esponjas abrasivas
- Productos inflamables o abrasivos como alcohol, acetona o disolventes
- Detergentes con tensioactivos no iónicos, limón o vinagre (ácido acético)



No lavar ni limpiar la parte superior del mueble con agua o líquidos.

Limpiar **UNA VEZ POR SEMANA** todas las partes externas del mueble.

Limpiar **UNA VEZ POR MES** todas las partes internas del mueble, siguiendo las instrucciones siguientes:

- Desconectar la alimentación eléctrica del mueble mediante el interruptor seccionador general instalado en la pared ("Fig. 24").
- Vaciar el mueble, almacenando la mercancía en cámaras o refrigeradores adecuados para mantener la temperatura de almacenamiento.
- Esperar a que el interior del mueble haya alcanzado la temperatura ambiente y proceder a la limpieza
- Después de comprobar cuidadosamente que el interior del mueble esté completamente seco, ponerlo en función otra vez volviéndolo a conectar.
- Después de un par de horas cargar la mercancía de nuevo.

Cuando se pone el mueble fuera de servicio, desconectar la alimentación y realizar las operaciones anteriores, dejando las puertas abiertas (Si alguna) para evitar olores desagradables.

CADA TRES MESES descongelar el mueble para permitir que se derrita el hielo que pueda haberse formado en las aletas del evaporador, impidiendo su correcto funcionamiento. La duración y el número de deshielos se regulan directamente en fábrica. Cualquier ajuste está reservado exclusivamente al servicio técnico de asistencia. El agua de deshielo es recogida por un desagüe especial. Comprobar periódicamente que el agua de deshielo fluya con normalidad. Si así no fuera, utilizar una sonda flexible no puntiaguda.

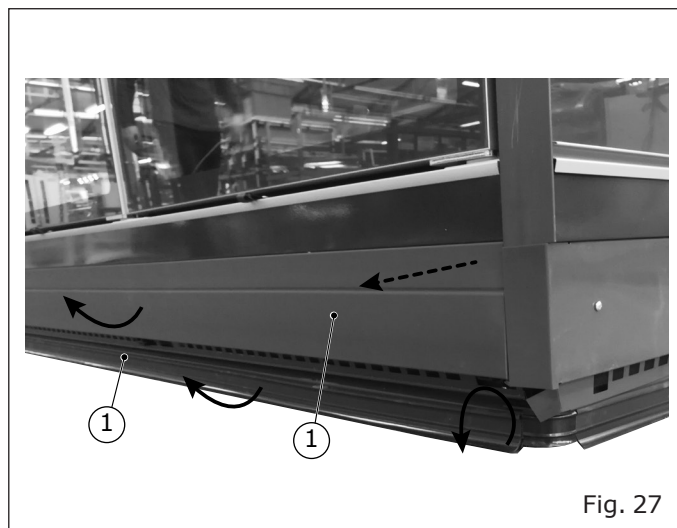

Fig. 27

1. Para quitar

Proceder como se indica para la limpieza **MENSUAL** de las partes internas, pero en este caso debe prever un tiempo de espera mayor para que el hielo se derrita completamente.

Modello - Modèle - Model Modell - Modelo - Modelo	GRANSESIA	COSTAN eptarefrigeration
Fabbricante - Constructeur - Manufacturer Hersteller - Fabricante - Fabricante	Epta Spa - Via Mecenate, 86 - 20138 Milano (MI) ITALIA Tel. 02/55403211 Telefax 02/55401023	18/20

IT

9.10 Situaciones de emergencia

FR

El mueble no arranca o se detiene:

- Comprobar que no haya una situación de apagón eléctrico.
- Controlar que el interruptor general de pared esté encendido.
- Controlar que el enchufe del mueble esté conectado a la toma de corriente.

EN

DE

ES

PT

Si el fallo de la alimentación eléctrica no depende de estos motivos, contactar con el centro de asistencia autorizado más cercano, vaciar completamente el mueble sacando los productos y almacenarlos de inmediato en las cámaras o refrigeradores idóneos a mantener la temperatura de conservación.

El mueble no enfría lo suficiente:

- Controlar que la carga del mueble sea correcta.
- Descongelar el mueble y reanudar el funcionamiento normal, si se han superado los tres meses de la última operación.
- Controlar que el mueble no esté colocado cerca de fuentes de calor o corrientes de aire.
- Comprobar las condiciones ambientales indicadas en "Condiciones ambientales" ("Tabla II").
- Utilizar un nivel de burbuja para comprobar la planaridad del mueble.

Si la falta de refrigeración persiste, contactar con el centro de asistencia autorizado más cercano.

El mueble es ruidoso:

- Controlar que los tornillos y pernos estén perfectamente apretados.
- Utilizar un nivel de burbuja para comprobar la planaridad del mueble.

Si el problema persiste, contactar con el centro de asistencia autorizado más cercano.

9.11 Asistencia técnica

Si fuera necesaria la intervención del personal de asistencia técnica, contactar inmediatamente con el proveedor al que compró el mueble.

Si es necesario utilizar piezas de recambio, dirigirse siempre al servicio técnico de asistencia: solicitar y comprobar que se utilicen piezas de recambio originales.

9.12 Desmantelamiento y eliminación

De acuerdo con las normas de eliminación de los residuos vigentes en cada país y por respeto al medio ambiente en el que vivimos, es importante separar las piezas del mueble para que puedan ser eliminadas por separado o, en su caso, recuperadas adecuadamente.

Todas las partes que componen el mueble no pueden tratarse como residuos urbanos, excepto las partes metálicas, que no están clasificadas como residuos especiales en la mayoría de los países europeos.



El sistema de refrigeración es de alta presión. Contactar con personal experto antes del desguace.

Los componentes del circuito de refrigeración no deben cortarse y/o separarse antes de vaciar el circuito. El personal cualificado debe recuperar el gas refrigerante.

Modello - Modèle - Model Modell - Modelo - Modelo	GRANSESIA	COSTAN eptarefrigeration
Fabbricante - Constructeur - Manufacturer Hersteller - Fabricante - Fabricante	Epta Spa - Via Mecenate, 86 - 20138 Milano (MI) ITALIA Tel. 02/55403211 Telefax 02/55401023	19/20

10. ADVERTENCIAS GENERALES ADICIONALES

Instrucciones para una correcta instalación y mantenimiento

Las instrucciones de uso y mantenimiento se describen en el Manual del Usuario disponible en el sitio:

www.eptarefrigeration.com.

Las instrucciones de instalación dedicadas al personal experto están disponibles:

- En la red de asistencia.
- En algunas categorías de producto, impresas en papel y entregadas con el producto.

Servicios profesionales de reparación

Los servicios son prestados por nuestra red de asistencia que puede ser consultada en el área de contactos en la dirección web www.eptarefrigeration.com.

Piezas de recambio

Las piezas de recambio y la información sobre las reparaciones de los aparatos están disponibles durante al menos 8 años después de que el producto haya sido descatalogado en la siguiente dirección web: www.epta-service.com/service.

Las credenciales de acceso se facilitan previa solicitud que se enviará por correo electrónico a: servicesupport@eptarefrigeration.com.

Limpieza del condensador de aire

Los aparatos de grupo incorporado con condensación de aire mantienen su eficacia sólo si el condensador se limpia según los métodos y plazos indicados en el manual de uso y mantenimiento.

Información importante sobre el desperdicio de alimentos

Se recomienda respetar atentamente las instrucciones de almacenamiento descritas en los envases de los productos y las instrucciones proporcionadas por los fabricantes de alimentos. Por lo tanto, las configuraciones de temperatura deben adaptarse a las características de conservación de los productos alimenticios de acuerdo con las indicaciones que figuran en nuestra documentación técnica.

Un uso inadecuado puede provocar su deterioro.

Condiciones ambientales

Este aparato está destinado a ser utilizado en entornos en los que la temperatura y la humedad respetan los límites especificados en el Manual de uso y mantenimiento.

Instrucciones de desmontaje

Para el desmontaje es necesario dirigirse a operadores profesionales.

El grupo Epta, que siempre ha prestado una especial atención al medio ambiente, pone a disposición de los usuarios los manuales de desmontaje y tratamiento de residuos de los muebles refrigerados plug-in que pueden descargarse a continuación.

- Manual de desmantelamiento de los muebles plug-in abiertos:



- Manual de desmantelamiento de los muebles plug-in cerrados:



Más información

Para obtener información más detallada, consultar www.eptarefrigeration.com y EPREL, a los que puede acceder mediante el código QR aquí o en la etiqueta energética del producto.



Modello - Modèle - Model Modell - Modelo - Modelo	GRANSESIA	COSTAN <small>epitarefrigeration</small>
Fabbricante - Constructeur - Manufacturer Hersteller - Fabricante - Fabricante	Epta Spa - Via Mecenate, 86 - 20138 Milano (MI) ITALIA Tel. 02/55403211 Telefax 02/55401023	20/20

IT

Límites de aplicación

FR



Este mueble está diseñado para su uso, transporte y almacenamiento hasta una altitud máxima de 2000 m sobre el nivel del mar.

EN

DE

Almacenamiento:

- Temperatura entre 15°C y 50°C.
- Humedad relativa entre 20% y 90%.
- Tiempo máximo 6 meses.

ES

PT

Transporte:

- Temperatura entre 20°C y 70°C.
- Humedad relativa entre 20% e 90%.
- Tiempo máximo 2 meses.

Instalación:

- Temperatura entre 0°C y 40°C.
- Humedad relativa entre 20% y 90%.
- Tiempo máximo 2 meses.

Uso

Las prestaciones del mueble no están garantizadas fuera de su uso normal. Su integridad y seguridad está garantizada dentro de los siguientes límites para condiciones temporales.

Entorno en el exterior del mueble:

- De clase 1 (16°C / 80%rh) a clase 4 (30°C / 55%rh) o clase 6 (27°C / 70%rh).

Entorno en el interior del mueble (condiciones de seguridad eléctrica):

Mueble de temperatura positiva

- Temperatura entre -10°C y +10°C.
- Humedad relativa entre 70% y 100%.
- Tiempo máximo 10 años.

Mueble de temperatura negativa

- Temperatura entre -40°C y 15°C.
- Humedad relativa entre 90% y 100%.
- Tiempo máximo 10 años.



Durante el funcionamiento de las resistencias se podrían registrar localmente temperaturas superiores a los límites indicados, pero respetando las condiciones de seguridad.

Modello - Modèle - Model Modell - Modelo - Modelo	GRANSESIA	COSTAN <small>eptarefrigeration</small>
Fabbricante - Constructeur - Manufacturer Hersteller - Fabricante - Fabricante	Epta Spa - Via Mecenate, 86 - 20138 Milano (MI) ITALIA Tel. 02/55403211 Telefax 02/55401023	1/20

ÍNDICE

1.	Introdução	2	IT
2.	Advertências de segurança	3	FR
2.1	Advertências gerais	3	EN
2.2	Advertências para a Manutenção do balcão	4	DE
2.3	Advertências elétricas	5	ES
2.4	Proibições	5	PT
3.	Descrição geral	6	
3.1	Seções	6	
4.	Transporte do balcão	7	
5.	Condições ambientais	8	
6.	Características técnicas	9	
7.	Utilização do balcão	10	
8.	Manutenção ordinária	13	
8.1	Limpeza do balcão	13	
9.	Indicações para o utilizador	14	
9.1	Descrição do balcão	14	
9.2	Transporte e movimentação	14	
9.3	Receção e armazenagem	14	
9.4	Instalação e condições ambientais	15	
9.5	Ligação elétrica	15	
9.6	Características técnicas	15	
9.7	Carregamento do produto	15	
9.8	Utilização do balcão	16	
9.9	Limpeza e manutenção ordinária	16	
9.10	Situações de emergência	18	
9.11	Assistência técnica	18	
9.12	Desmantelamento e eliminação	18	
10.	Advertências gerais adicionais	19	

SIMBOLOGIA UTILIZADA



Símbolo proibição: proíbe efetuar determinadas operações.



Símbolo atenção: normas contra acidentes para o operador.



Símbolo advertências: existe a possibilidade de danificar o balcão e/ou os seus componentes.



Símbolo nota: fornece informações úteis.

Modello - Modèle - Model Modell - Modelo - Modelo	GRANSESIA	COSTAN eptarefrigeration
Fabbricante - Constructeur - Manufacturer Hersteller - Fabricante - Fabricante	Epta Spa - Via Mecenate, 86 - 20138 Milano (MI) ITALIA Tel. 02/55403211 Telefax 02/55401023	2/20

IT

1. INTRODUÇÃO

FR

Recomenda-se ler com atenção o conteúdo do presente Manual e conservá-lo junto com o balcão.

EN

O fabricante não pode ser responsabilizado por danos causados a pessoas ou coisas devido à falta de observância das advertências contidas neste Manual.

DE

ES

PT



O presente Manual contém informações consideradas necessárias para a boa utilização e funcionamento do balcão.

No seu interior estão presentes as seguintes descrições e informações:

- uma descrição das funções do balcão e de todas as suas partes
- informações relativas à segurança do balcão e as regras contra acidentes a observar
- uma utilização correta do balcão
- uma correta manutenção ordinária e programada, incluindo as operações de limpeza

informações não contidas no presente Manual:

- Instruções relativas à instalação

Para a instalação correta do balcão remeter-se aos seguintes documentos:

- Manual Técnico
- Instruções de consulta rápida

O presente Manual destina-se às seguintes figuras profissionais:

- **OPERADOR QUALIFICADO**, pessoa qualificada, formada para o funcionamento, a regulação, a limpeza e a manutenção ordinária do móvel
- **TÉCNICO ESPECIALIZADO** técnico treinado e autorizado pelo organismo indicado no contrato (fabricante/concessionário/distribuidor) a realizar a instalação, manutenção extraordinária, reparação, substituição e revisão do balcão

As instruções também estão disponíveis para: www.eptarefrigeration.com.

Remeter-se à declaração de conformidade para os regulamentos e as certificações do balcão.

Guarde sempre o folheto de instruções e em caso de venda.

Modello - Modèle - Model Modell - Modelo - Modelo	GRANSESIA	COSTAN eptarefrigeration
Fabbricante - Constructeur - Manufacturer Hersteller - Fabricante - Fabricante	Epta Spa - Via Mecenate, 86 - 20138 Milano (MI) ITALIA Tel. 02/55403211 Telefax 02/55401023	3/20

2. ADVERTÊNCIAS DE SEGURANÇA

2.1 Advertências gerais



O fabricante não pode ser responsabilizado danos causados a pessoas ou a coisas devido à falta de observância das advertências contidas neste manual. Qualquer pessoa que utilizar este balcão deverá ler o presente manual de utilização.



O empregador terá de formar o pessoal relativamente aos riscos decorrentes de acidentes, sobre os dispositivos preparados para a segurança do pessoal, riscos de emissão de ruído e regras gerais contra acidentes previstas pelas normas em vigor.



O balcão tem de ser utilizado por pessoas adultas que tenham um conhecimento necessário e cujas capacidades físicas, sensoriais ou mentais não sejam reduzidas; o balcão não foi concebido para ser utilizado por menores (especialmente de 0 a 3 anos). É da responsabilidade dos adultos supervisionar as crianças para que elas não brinquem com o balcão.



Qualquer outra utilização não explicitamente indicada neste manual é de considerar perigosa, não podendo o fabricante se responsabilizar por eventuais danos decorrentes de utilização indevida, errada e não razoável.



O balcão tem de ser utilizado por pessoal dotado de adequados dispositivos de proteção individuais.



É obrigatório utilizar luvas de trabalho.



Não deixar o balcão exposto aos agentes atmosféricos.



Não utilizar jactos de água diretos ou indiretos sobre o balcão.



Não mexer no balcão com as mãos e os pés molhados ou húmidos e não utilizar o balcão descalços.



A remoção de proteções ou de painéis que exigem a utilização de ferramenta para ser removidos é reservada exclusivamente ao pessoal qualificado.



Para a montagem de acessórios opcionais dedicados, dirigir-se ao centro de assistência autorizado mais próximo.



Qualquer intervenção terá de ser efetuada exclusivamente por pessoal qualificado e, de qualquer modo, antes de qualquer intervenção, é necessário desligar a alimentação elétrica do seccionador.

IT

FR

EN

DE

ES

PT

Modello - Modèle - Model Modell - Modelo - Modelo	GRANSESIA	COSTAN <small>eptarefrigeration</small>
Fabbricante - Constructeur - Manufacturer Hersteller - Fabricante - Fabricante	Epta Spa - Via Mecenate, 86 - 20138 Milano (MI) ITALIA Tel. 02/55403211 Telefax 02/55401023	4/20

IT
FR
EN
DE
ES
PT

 Formar quem utilizar o balcão sobre a posição do interruptor seccionador.

 A regulação do termóstato deve ser feita somente pelo serviço de assistência técnica autorizado.

 Prestar atenção às partes quentes ou em movimento marcadas com o símbolo adequado.

 Em caso de incêndio, não utilizar água para apagar as chamas mas apenas extintores a seco.

 Não danificar o circuito refrigerante.

 Evitar fogueiras ou faíscas no interior do aparelho.

 Manter livres de obstruções as aberturas de ventilação no invólucro do aparelho.

 Não utilizar aparelhos elétricos no interior dos compartimentos do aparelho para a conservação dos alimentos congelados se estes não forem do tipo recomendado pelo fabricante.

 Não conservar substâncias explosivas ou perigosas, como recipientes sob pressão com propelente inflamável, neste aparelho.

 Não deixar pesos em cima da parte superior do balcão; Convém evitar colocar alimentos não embalados diretamente nas prateleiras, mas utilizar recipientes específicos para alimentos.

 Não coloque recipientes com líquidos e não derrame líquidos sobre o balcão.

2.2 Advertências para a Manutenção do balcão

 O acesso a partes elétricas e/ou a partes que exigem a utilização de ferramenta é reservado aos técnicos especializados.

 Antes de efetuar qualquer operação de manutenção e limpeza reservadas ao utilizador, retirar tensão ao balcão através do interruptor seccionador geral colocado na parede.

 Prestar atenção às partes quentes ou em movimento marcadas com o símbolo adequado.

 É obrigatório utilizar luvas de trabalho.

Modello - Modèle - Model Modell - Modelo - Modelo	GRANSESIA	COSTAN eptarefrigeration
Fabbricante - Constructeur - Manufacturer Hersteller - Fabricante - Fabricante	Epta Spa - Via Mecenate, 86 - 20138 Milano (MI) ITALIA Tel. 02/55403211 Telefax 02/55401023	5/20

2.3 Advertências elétricas



Verificar se a tensão de alimentação corresponde aos dados que constam da placa de características do balcão.



A instalação elétrica tem de ser efetuada, segundo as normas, por técnicos especializados.



A remoção da tampa do quadro elétrico tem de ser efetuada por técnicos especializados.



De acordo com as regras de instalação, a rede de alimentação tem de incluir um dispositivo para a desligação onipolar que assegure a desligação completa da rede nas condições da categoria de sobretensão III.



A instalação do balcão tem de ser efetuada de acordo com as instruções do fabricante, por pessoal profissionalmente qualificado e de acordo com as normas sobre as instalações elétricas em vigor nos vários Países.



Uma instalação errada do balcão pode provocar danos a pessoas, animais ou coisas, em relação aos quais o fabricante não pode ser considerado responsável.



Se o cabo de alimentação estiver danificado, deve ser substituído por pessoal de serviço autorizado. Não tente consertar o cabo.



Não ligue a bancada se estiver danificada. Em caso de dúvida, contacte o serviço pós-venda ou o seu revendedor.

2.4 Proibições



É proibido utilizar dispositivos além dos fornecidos no balcão do produtor, para acelerar o processo de descongelamento.



É proibido, por pessoal não especializado, remover a tampa do quadro elétrico ou abrir painéis que exigem a utilização de ferramenta.



É proibido utilizar o balcão para a conservação e/ou a exposição de substâncias explosivas, inflamáveis ou corrosivas, como por exemplo embalagens spray com um propelente inflamável.



É proibido utilizar o balcão para a conservação e/ou a exposição de produtos farmacêuticos.



É proibido, em caso de PRODUTOS NÃO EMBALADOS OU CONSERVADOS A BAIXA TEMPERATURA, utilizar o balcão para a conservação e/ou a exposição de garrafas e embalagens de vidro.



É proibido colocar o balcão em ambientes em que estão presentes substâncias gasosas explosivas.



É proibido remover a placa de características do balcão.



É proibido subir no balcão ou no pára-choque do balcão.

IT

FR

EN

DE

ES

PT

Modello - Modèle - Model Modell - Modelo - Modelo	GRANSESIA	COSTAN eptarefrigeration
Fabbricante - Constructeur - Manufacturer Hersteller - Fabricante - Fabricante	Epta Spa - Via Mecenate, 86 - 20138 Milano (MI) ITALIA Tel. 02/55403211 Telefax 02/55401023	6/20

IT
FR
EN
DE
ES
PT

3. DESCRIÇÃO GERAL

3.1 Seções

COMPACT

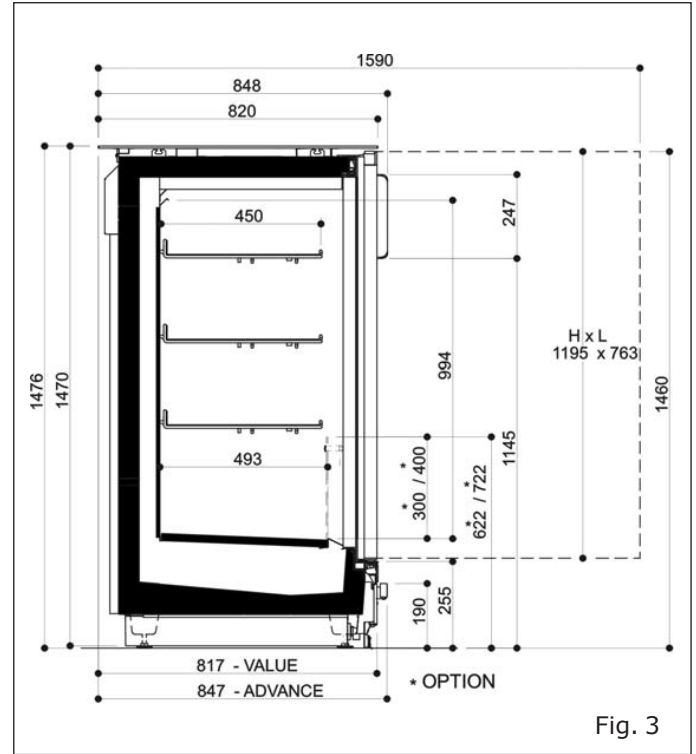

Fig. 3

NARROW

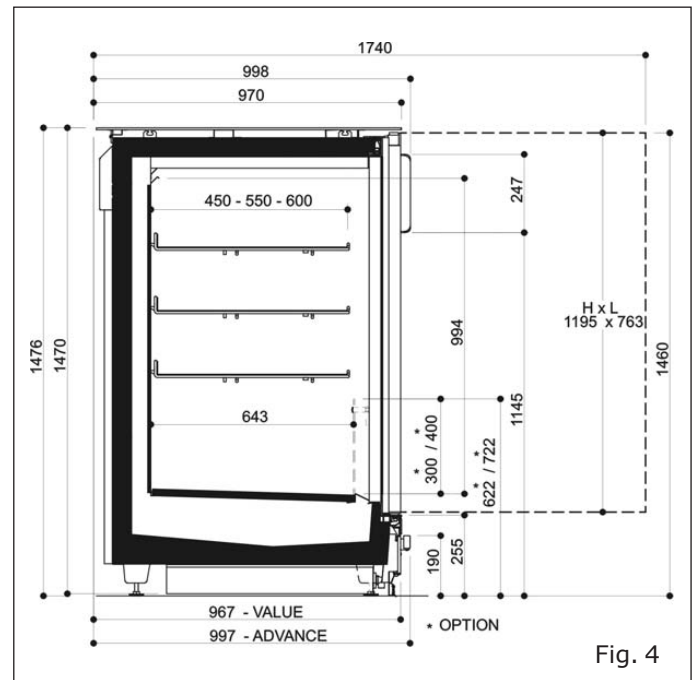

Fig. 4

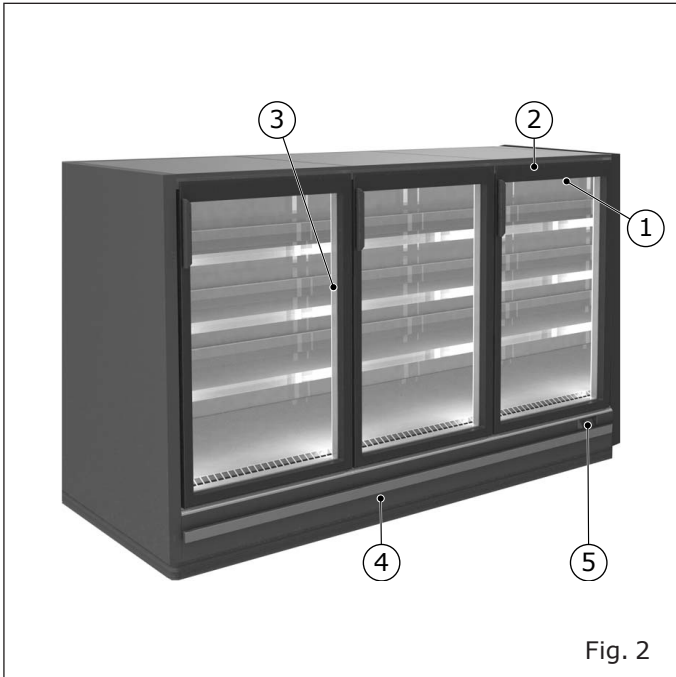

Fig. 2

1. Placa de características
2. Interruptor das luzes
3. Iluminação
4. Proteções em aço para proteger os balcões (opcional)
5. Teletermóstato

Modello - Modèle - Model Modell - Modelo - Modelo	GRANSESIA	COSTAN eptarefrigeration
Fabbricante - Constructeur - Manufacturer Hersteller - Fabricante - Fabricante	Epta Spa - Via Mecenate, 86 - 20138 Milano (MI) ITALIA Tel. 02/55403211 Telefax 02/55401023	7/20

4. TRANSPORTE DO BALCÃO



1. Pontos de levantamento

Tab. I

Modelo		Peso (quilos)	Peso com embalagem (quilos)
2D	COMPACT	350	490
3D		500	550
2D EOL		350	490
2D	NARROW	350	490
3D		500	550
EOL 3D-S		500	550

Modello - Modèle - Model Modell - Modelo - Modelo	GRANSESIA	COSTAN eptarefrigeration
Fabbricante - Constructeur - Manufacturer Hersteller - Fabricante - Fabricante	Epta Spa - Via Mecenate, 86 - 20138 Milano (MI) ITALIA Tel. 02/55403211 Telefax 02/55401023	8/20

IT
FR
EN
DE
ES
PT

5. CONDIÇÕES AMBIENTAIS



Fig. 7



Fig. 9

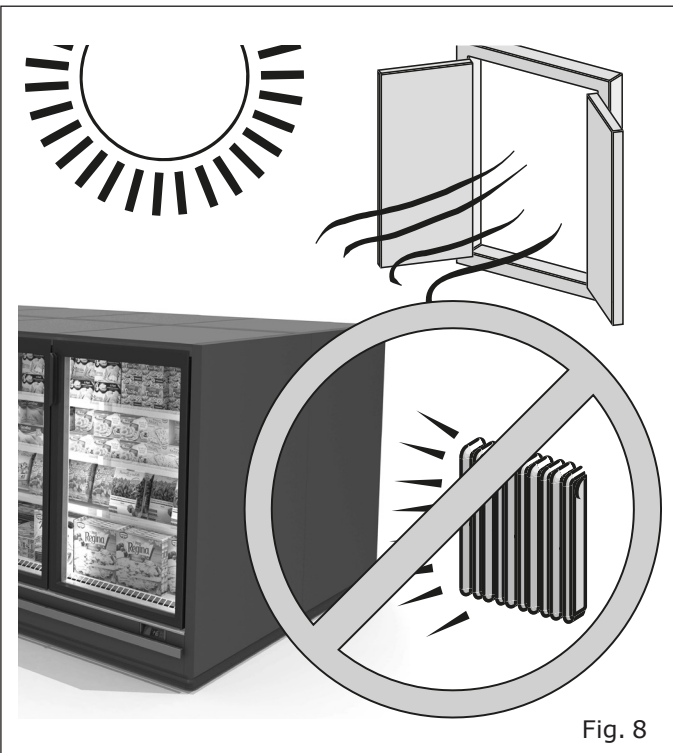

Fig. 8

Tab. II

Caraterísticas	
Tipo de local	Fechado
Temperatura	25°C
Humidade relativa	60 %
Iluminação	600 lx

Modello - Modèle - Model Modell - Modelo - Modelo	GRANSESIA	COSTAN eptarefrigeration
Fabbricante - Constructeur - Manufacturer Hersteller - Fabricante - Fabricante	Epta Spa - Via Mecenate, 86 - 20138 Milano (MI) ITALIA Tel. 02/55403211 Telefax 02/55401023	9/20

6. CARACTERÍSTICAS TÉCNICAS







 <small>EPTA S.p.A. Via Mecenate, 86 20138 Milano - Italy</small>		12
1	2	SN 13  14 REF 15 16
RATED BEMESSUNG ASSIGNÉ NOMINALE NOMINAL 3 4 5 6		REFRIGERANT KÄLTEMITTEL RÉFRIGÉRANT REFRIGERANTE REFRIGERANTE 17 18 19 20
DEFROSTING ABTAUUNG DÉGIVRAGE SBRINAMENTO DESCONGELAMIENTO 7 8		CLIMATIC CLASS KLIMAKLASSE CLASSE CLIMATICA CLASSE CLIMATICA CLASE CLIMÁTICA 21
HEATING SYSTEMS HEIZUNGSSYSTEME SYSTEMES CHAUFFANTS SISTEMI DI RISCALDAMENTO SISTEMA DE CALEFACCIÓN 9		INSULATION BLOWING GAS ISOLATIONSGAS (BLÄHGAS) AGENT MOUSSANT D' ISOLATION GAS ESPANDENTE ISOLAMENTO AGENTE ESPUMANTE 22
 10		PROTECTION INDEX SCHUTZART INDEX DE LA PROTECTION INDICE DI PROTEZIONE ÍNDICE DE PROTECCIÓN 23
 <small>Read Operator's Manual available at www.eptarefrigeration.com or calling +39 0437 968379</small> 11		24  

Fig. 10

- | | |
|---|---|
| <ul style="list-style-type: none"> 1. Origem do produto 2. Produto no "País de origem" 3. Tensão nominal 4. Potência nominal 5. Frequência nominal 6. Corrente nominal 7. Potência de descongelamento 8. Corrente de descongelamento 9. Sistema de aquecimento 10. Sistema de iluminação 11. Manual do operador 12. Código de barras 13. Número de série | <ul style="list-style-type: none"> 14. Data de produção 15. Código hat 16. Modelo 17. Tipo de refrigerante 1 18. Massa refrigerante 1 19. Tipo de refrigerante 2 20. Massa refrigerante 2 21. Classe climática 22. Isolamento gás 23. Índice de proteção 24. Marca de certificação 25. Marca RAEE |
|---|---|





É obrigatória a utilização de separadores interiores entre as prateleiras e na base para assegurar o funcionamento correto do balcão. Para a versão de 3 portas os separadores são fornecidos de série.

Modello - Modèle - Model Modell - Modelo - Modelo	<h1>GRANSESIA</h1>	
Fabbricante - Constructeur - Manufacturer Hersteller - Fabricante - Fabricante	Epta Spa - Via Mecenate, 86 - 20138 Milano (MI) ITALIA Tel. 02/55403211 Telefax 02/55401023	10/20

IT
FR
EN
DE
ES
PT

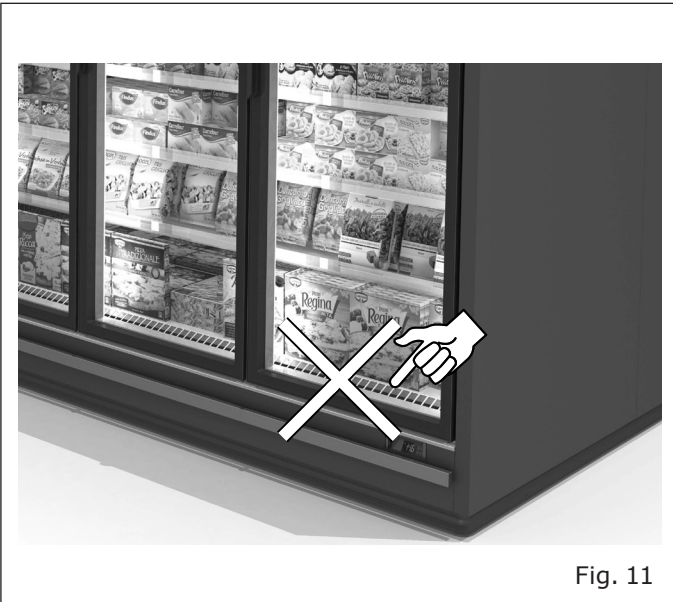
7. UTILIZAÇÃO DO BALCÃO



 Não tapar

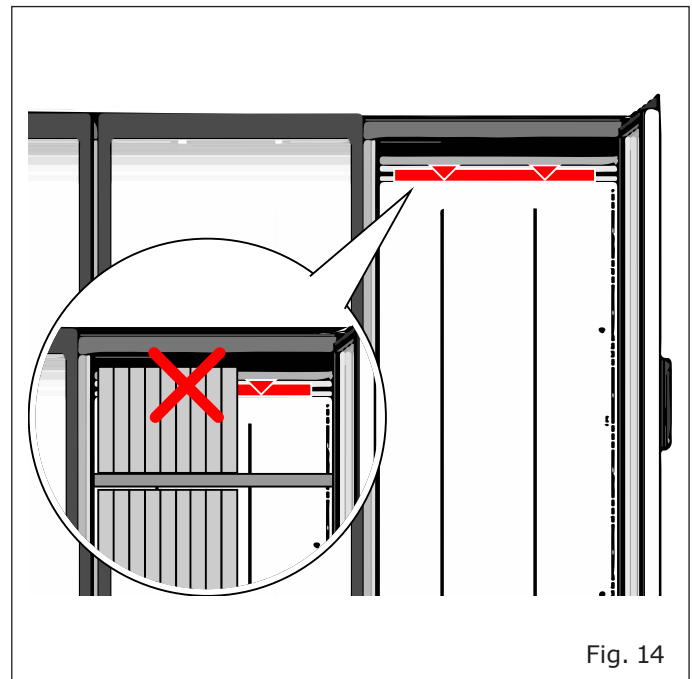
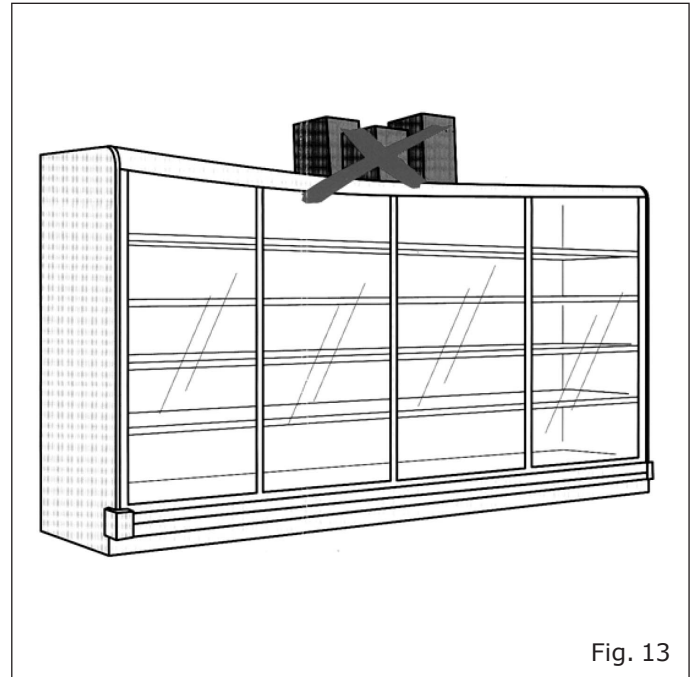

 Respeitar a linha de carregamento

Modello - Modèle - Model Modell - Modelo - Modelo	<h1>GRANSESIA</h1>	
Fabbricante - Constructeur - Manufacturer Hersteller - Fabricante - Fabricante	Epta Spa - Via Mecenate, 86 - 20138 Milano (MI) ITALIA Tel. 02/55403211 Telefax 02/55401023	11/20

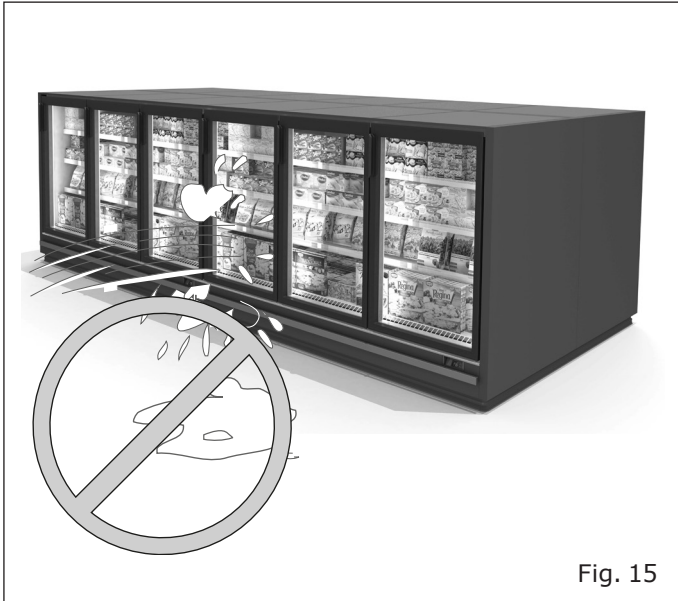

Fig. 15

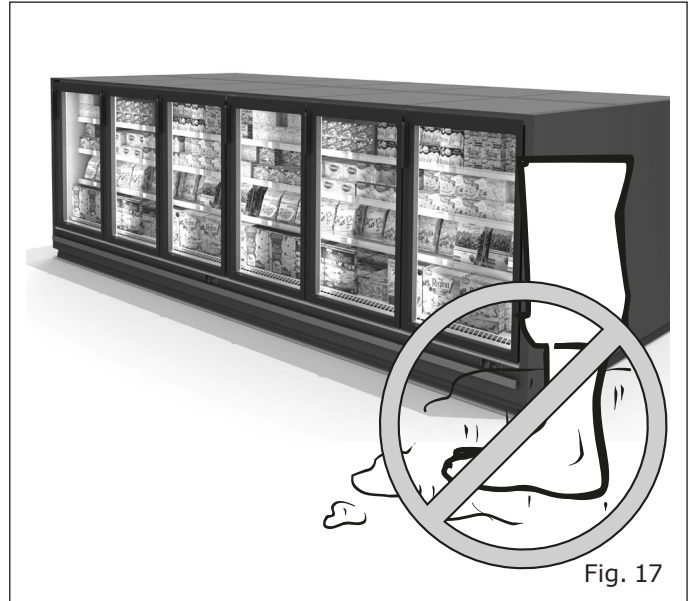

Fig. 17

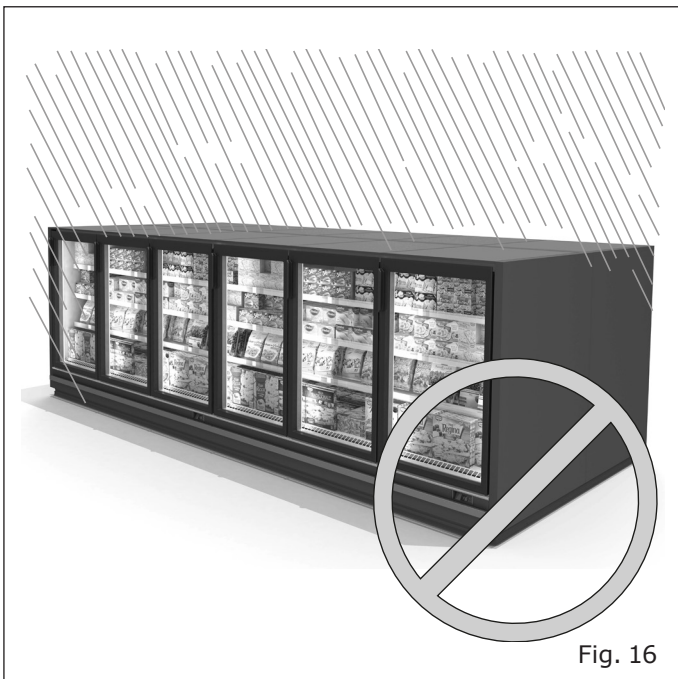

Fig. 16

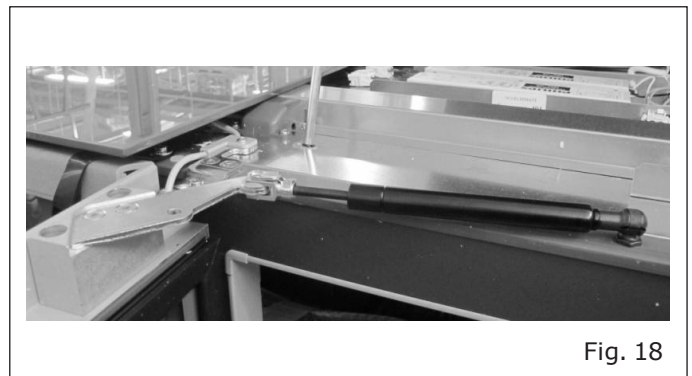

Fig. 18



Fig. 19

- IT
- FR
- EN
- DE
- ES
- PT

Modello - Modèle - Model Modell - Modelo - Modelo	<h1>GRANSESIA</h1>	
Fabbricante - Constructeur - Manufacturer Hersteller - Fabricante - Fabricante	Epta Spa - Via Mecenate, 86 - 20138 Milano (MI) ITALIA Tel. 02/55403211 Telefax 02/55401023	12/20

IT
FR
EN
DE
ES
PT



Fig. 20

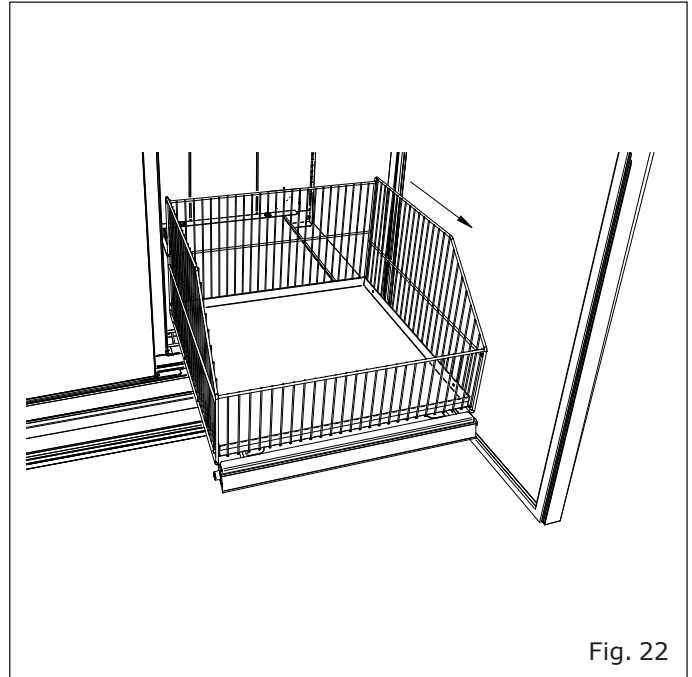

Fig. 22



Fig. 21

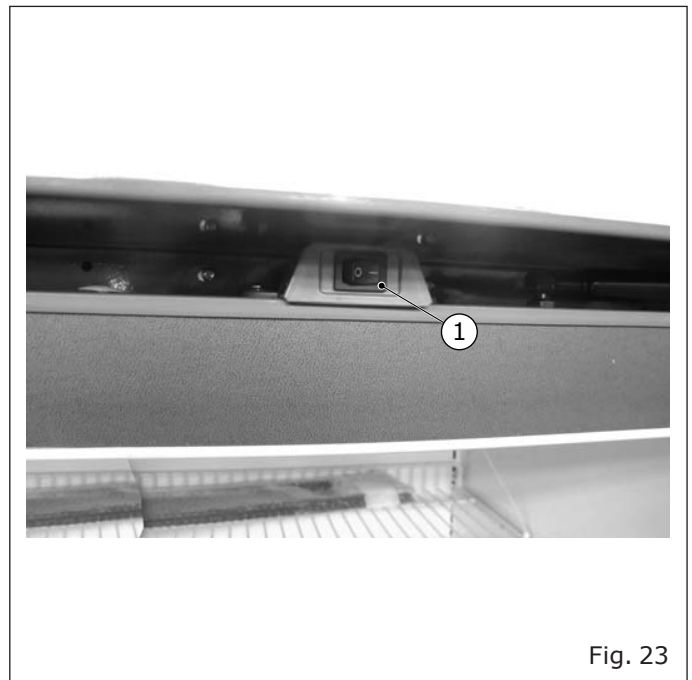

Fig. 23

1. Interruptor de luz

Modello - Modèle - Model Modell - Modelo - Modelo	GRANSESIA	
Fabbricante - Constructeur - Manufacturer Hersteller - Fabricante - Fabricante	Epta Spa - Via Mecenate, 86 - 20138 Milano (MI) ITALIA Tel. 02/55403211 Telefax 02/55401023	13/20

8. MANUTENÇÃO ORDINÁRIA

8.1 Limpeza do balcão

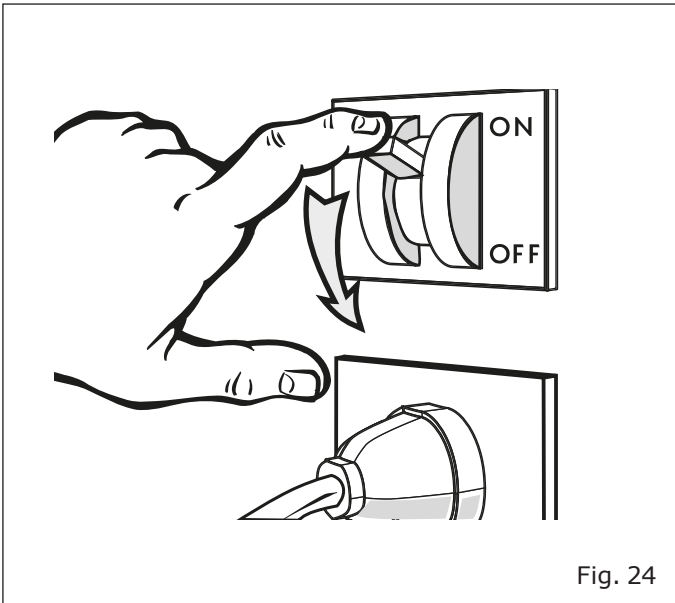

Fig. 24



Fig. 25

Modello - Modèle - Model Modell - Modelo - Modelo	GRANSESIA	COSTAN eptarefrigeration
Fabbricante - Constructeur - Manufacturer Hersteller - Fabricante - Fabricante	Epta Spa - Via Mecenate, 86 - 20138 Milano (MI) ITALIA Tel. 02/55403211 Telefax 02/55401023	14/20

9. INDICAÇÕES PARA O UTILIZADOR

9.1 Descrição do balcão

Esta linha de balcões é adequada para a conservação e exposição de gelados e produtos congelados.

CLASSE DE TEMPERATURA (de acordo com EN ISO 23953-2): 3L1.

As características gerais e as dimensões são ilustradas nas figuras e nas seções contidas em "Descrição geral" (até à pág."7").

Durante as fases de transporte e movimentação, receção e armazenagem, instalação, carregamento, utilização, limpeza e manutenção, eliminação, prestar atenção ao risco de viragem do balcão ("Fig. 26").

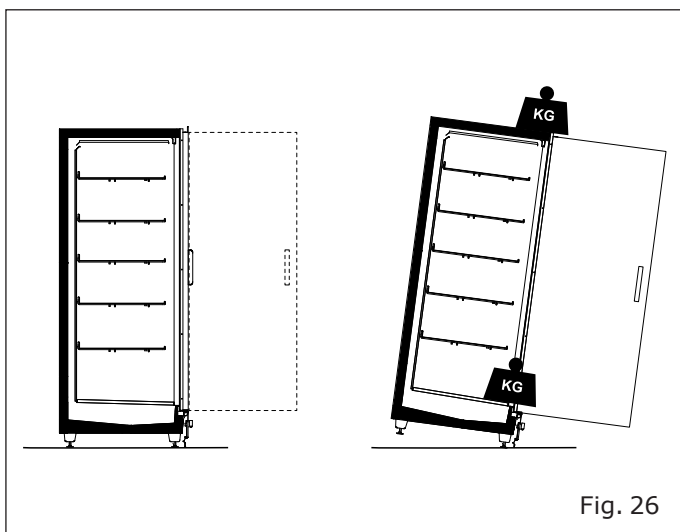

Fig. 26

9.2 Transporte e movimentação

O balcão é contido numa embalagem específica dotada de estrado para a movimentação com empilhadores.

Para o transporte e a movimentação do balcão utilizar:

- Exclusivamente um estrado adequado ou equivalente
- Um empilhador à mão ou elétrico adequado para o levantamento do balcão, com características idóneas que respeitem as Normas em vigor

Os pesos do balcão (vazio e com a embalagem) e as dimensões da embalagem encontram-se em "Transporte do balcão" (tabela "Tab. I" e figuras na pág."8").

As operações de movimentação devem ser efetuadas por pessoal qualificado, apto para avaliar pesos, pontos de levantamento e meios mais idóneos tanto para a segurança como para o caudal.

9.3 Receção e armazenagem

Controlar as condições de embalagem antes de aceitar a entrega do balcão pelo despachante.

Em caso de danos evidentes na embalagem:

- Remover a embalagem do balcão em presença do despachante.
- Assinar, com reserva, o documento de entrega.

O fabricante não pode ser responsabilizado por eventuais danos devido ao transporte ou a uma armazenagem errada do balcão.

O balcão tem de ser conservado em lugar protegido do sol e das intempéries, a uma temperatura entre -25°C e +55°C e uma humidade relativa do ar entre 30% e 95%.

Modello - Modèle - Model Modell - Modelo - Modelo	GRANSESIA	
Fabbricante - Constructeur - Manufacturer Hersteller - Fabricante - Fabricante	Epta Spa - Via Mecenate, 86 - 20138 Milano (MI) ITALIA Tel. 02/55403211 Telefax 02/55401023	15/20

9.4 Instalação e condições ambientais

O balcão não foi projetado para ser instalado no exterior.

Para um funcionamento correto do balcão, verificar se está posicionado:

- Num chão nivelado ("Fig. 7").
- Longe de fontes de calor, da radiação direta do sol, de portas, janelas, ventiladores e bocas de ventilação ("Fig. 8").

Assegurar o espaço necessário para os clientes que utilizam o balcão.

As condições do ambiente no qual colocar o balcão encontram-se em "Condições ambientais".

9.5 Ligação elétrica

A montante do balcão tem de ser instalado um interruptor seccionador omnipolar. Este tem de ter:

- Distância mínima dos contactos de 3 mm.
- Poder de interrupção adequado

O interruptor seccionador tem de ser colocado numa posição tal que o torne facilmente operacional em situações de emergência (distância máxima de 3 m).

Antes de ligar o balcão, verificar se a tensão de alimentação corresponde aos dados que constam da placa de características do balcão. Para garantir um funcionamento regular, a variação máxima de tensão tem de estar incluída entre +/- 6% do valor nominal.

9.6 Características técnicas

A placa de características indica os dados técnicos do balcão. A sua posição e a tipologia de dados encontram-se em "Características técnicas" ("Fig. 10").

Esquemas elétricos, listas de calibrações dos instrumentos de controle, instruções de instalação e cópia da Declaração de Conformidade estão disponíveis no site <https://documents.eptarefrigeration.com>.

O nível de pressão sonora gerado pelo funcionamento do balcão é inferior a 70 dB(A). O balcão não provoca vibrações prejudiciais.

9.7 Carregamento do produto

Transmitir tensão ao balcão para iniciar o seu ciclo de arrefecimento, carregando no interruptor seccionador geral colocado na parede. Depois de cerca 2 horas é possível carregar o balcão.

O balcão é adequado para conservar a temperatura da mercadoria e não para a baixar; os alimentos, portanto, terão de ser colocados no seu interior apenas se tiverem sido arrefecidos segundo as respetivas temperaturas de conservação. Produtos que tiverem sofrido aquecimento nunca devem ser colocados no balcão.

Em presença de vidros na parte da frente do balcão, aconselha-se efetuar o carregamento da mercadoria quando no espaço de venda não estiverem presentes clientes.

Durante o carregamento da mercadoria, fazer com que:

- A carga seja homogénea por dimensão e qualidade da mesma mercadoria
- A mercadoria não obstrua o correto fluxo do ar refrigerado ("Fig. 11").
- A mercadoria não ultrapasse a linha de carga ("Fig. 14").

Carga máxima admissível distribuída de modo uniforme:

- Nas prateleiras: 160 kg/m²
- Na prateleira ao fundo: 225 kg/m²

Modello - Modèle - Model Modell - Modelo - Modelo	GRANSESIA	COSTAN eptarefrigeration
Fabbricante - Constructeur - Manufacturer Hersteller - Fabricante - Fabricante	Epta Spa - Via Mecenate, 86 - 20138 Milano (MI) ITALIA Tel. 02/55403211 Telefax 02/55401023	16/20

IT
FR
EN
DE
ES
PT



A porta foi projetada para ficar aberta SEM NENHUM SISTEMA DE BLOQUEIO MECÂNICO, simplesmente abrindo-a de 90°. Além disso, o sistema de fecho "soft-closing" assegura um fecho automático lento e suave na parte final sem que seja necessário forçar o fecho. Por esta razão NÃO É NECESSÁRIO ABRIR a porta para além dos 90° e bloqueá-la com pesos ou MANTÊ-LA em posição se já estiver aberta a 90° ("Fig. 19, "Fig. 21").



Durante a fase de carregamento se estiverem presentes cestos deslizantes (opcionais) não devem ser extraídos todos simultaneamente ("Fig. 22").

9.8 Utilização do balcão

Iluminação

A iluminação do balcão é comandada por um interruptor colocado no balcão, na parte de cima à direita.

Termóstato/termómetro

No balcão, na parte inferior à direita, está posicionado um termóstato/termómetro remoto para o controle da temperatura.

9.9 Limpeza e manutenção ordinária

Fazer com que haja uma boa visibilidade na área de intervenção, eventualmente servindo-se de mais uma fonte de iluminação.



Revestimento anti-embaciamento das portas LOW CONSUMPTION. As portas do móvel têm um revestimento anti-embaciamento que previne a formação de embaciamento em qualquer condição de temperatura e humidade, mesmo depois de prolongados mergulhos na água ou limpezas frequentes. Imensamente hidrófilo, o revestimento produz pequenas gotas de água que se propagam e não se transformam em embaciamento. Embora absorvendo a humidade, o revestimento não derrete na água e, por conseguinte, se molhado não fica manchado. A película não é danificada por detergentes comerciais específicos para vidro, tira-nódoas, amoníaco, álcool e gasolina e não descolora se ficar exposta ao sol ou ao calor.

As portas são fornecidas com revestimento anti-embaciamento laminado no vidro interior e protegido por uma camada.

A camada de proteção fica parcialmente levantada nos lados para facilitar a sua remoção em fase de utilização. A remoção da camada de proteção tem de ocorrer depois da instalação das portas sobre o balcão, uma vez que o balcão tiver alcançado a temperatura de utilização. Isto para permitir o funcionamento imediato da película anti-embaciamento.

Para voltar a este passo, na película de proteção está colocada a seguinte etiqueta: "DO NOT REMOVE THE PROTECTIVE FILM UNTIL THE CABINET HAS REACHED THE OPERATING TEMPERATURE".

Modello - Modèle - Model Modell - Modelo - Modelo	GRANSESIA	COSTAN eptarefrigeration
Fabbricante - Constructeur - Manufacturer Hersteller - Fabricante - Fabricante	Epta Spa - Via Mecenate, 86 - 20138 Milano (MI) ITALIA Tel. 02/55403211 Telefax 02/55401023	17/20

Limpeza do balcão

Utilizar exclusivamente água à temperatura máxima de 65°C e sabão ou detergente neutro para uso doméstico diluído em água.

Para as superfícies envidraçadas utilizar exclusivamente produtos para a limpeza dos vidros. Aconselha-se evitar a utilização de água porque poderia depositar calcário na superfície do vidro.

Não utilizar por nenhuma razão:

- Esponjas abrasivas
- Produtos inflamáveis ou abrasivos como álcool, acetona ou solventes
- Detergentes que contêm tensoativos não iónicos, limão ou vinagre (ácido acético)



Não lavar ou limpar com água ou líquidos a parte superior do balcão.

Limpar **UMA VEZ POR SEMANA** todas as partes exteriores do balcão.

Limpar **UMA VEZ POR MÊS** todas as partes interiores do balcão, seguindo as instruções abaixo indicadas:

- Retirar a tensão elétrica ao balcão através do interruptor seccionador geral colocado na parede ("Fig. 24").
- Esvaziar o balcão, armazenando a mercadoria em câmaras frigoríficas ou refrigeradores específicos para manter a temperatura de conservação da mesma.
- Aguardar que o interior do balcão tenha alcançado a temperatura ambiente e proceder à limpeza
- Depois de ter controlado com atenção que o interior do balcão esteja completamente seco, colocar de novo em função o aparelho, transferindo tensão ao balcão.
- Depois de cerca duas horas colocar de novo a mercadoria.

Quando se colocar o armário fora de serviço, desligar a alimentação e seguir os passos anteriores, deixando as portinholas abertas (se disponível) para evitar maus cheiros.

Proceder **CADA TRÊS MESES** o descongelamento do balcão para permitir o derretimento do gelo que porventura se formou na alhetas do evaporador não permitindo o funcionamento correto. A duração e o número de descongelamentos são regulados diretamente na fábrica. Eventuais regulações são reservadas exclusivamente ao serviço técnico de assistência. A água de descongelamento é recolhida numa descarga adequada. Verificar periodicamente se a água de descongelamento escorre normalmente. Em caso contrário intervir mediante uma sonda flexível não pontiaguda.

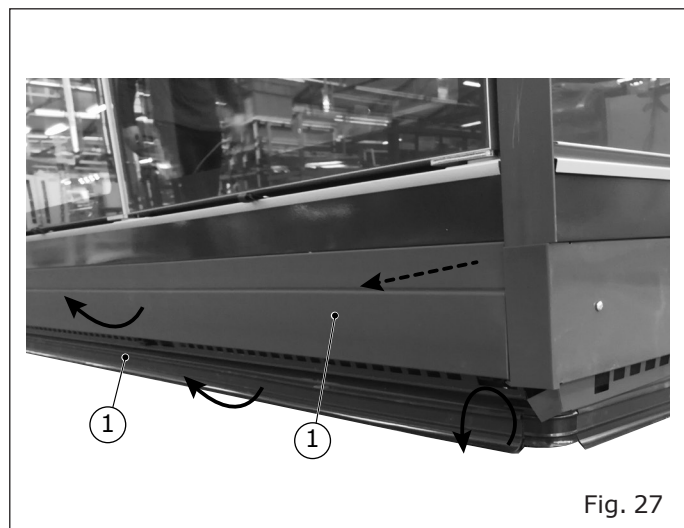

Fig. 27

1. Remover

Atuar como indicado para a limpeza **MENSAL** das partes intrieores, mas neste caso será necessário prever um tempo de espera mais longo para permitir o descongelamento completa do gelo.

Modello - Modèle - Model Modell - Modelo - Modelo	GRANSESIA	COSTAN eptarefrigeration
Fabbricante - Constructeur - Manufacturer Hersteller - Fabricante - Fabricante	Epta Spa - Via Mecenate, 86 - 20138 Milano (MI) ITALIA Tel. 02/55403211 Telefax 02/55401023	18/20

IT

9.10 Situações de emergência

FR

O balcão não arranca ou pára:

- Verificar que não esteja presente uma situação de blackout elétrico.
- Controlar que o interruptor geral colocado na esteja ligado.
- Controlar que a ficha do balcão esteja introduzida na tomada de corrente.

EN

DE

ES

PT

Se a interrupção elétrica não depender destas razões, dirigir-se ao centro de assistência autorizado mais próximo e proceder ao esvaziamento completo e à armazenagem imediata do produto em arcas frigoríficas ou refrigeradores específicos para manter a temperatura de conservação.

O balcão não arrefece suficientemente:

- Controlar se o carregamento do balcão está correto.
- Descongelar o balcão para depois retomar o funcionamento normal.
- Controlar que o balcão não se encontre próximo de fontes de calor ou correntes de ar.
- Verificar as condições ambientais indicadas em "Condições ambientais" ("Tab. II").
- Controlar, através de uma bolha de nível, a planaridade do balcão.

Se a falha de arrefecimento persistir, dirigir-se ao centro de assistência autorizado mais próximo.

O balcão faz ruído:

- Controlar se os parafusos e as porcas estão perfeitamente fechados.
- Controlar, através de uma bolha de nível, a planaridade do balcão.

Se o inconveniente persistir, dirigir-se ao centro de assistência autorizado mais próximo.

9.11 Assistência técnica

Se se tornar necessária a intervenção do pessoal técnico de assistência, contactar de imediato o fornecedor que vendeu o balcão.

Se se tornar necessária a utilização de peças sobresselentes remeter-se sempre ao serviço técnico de assistência: pedir e apurar que sejam utilizadas peças sobresselentes originais.

9.12 Desmantelamento e eliminação

De acordo com as normas para o desmantelamento dos resíduos em vigor em cada País e respeitando o ambiente no qual vivemos, pedimos para dividirem o balcão em duas partes por forma a poder eliminar separadamente e eventualmente recuperá-las adequadamente.

Todas as partes que compõem o balcão não são assimiladas aos resíduos sólidos urbanos, excepto para peças metálicas que, no entanto, não estão incluídas entre os resíduos especiais para a maioria dos Países Europeus.



O sistema de refrigeração é de alta pressão. Contactar pessoal especializado no desmantelamento.

Os componentes do circuito de refrigeração não devem ser cortados e/ou separados antes que seja desligado o circuito, sendo a recuperação do gás refrigerante efetuada por pessoal qualificado.

Modello - Modèle - Model Modell - Modelo - Modelo	GRANSESIA	COSTAN eptarefrigeration
Fabbricante - Constructeur - Manufacturer Hersteller - Fabricante - Fabricante	Epta Spa - Via Mecenate, 86 - 20138 Milano (MI) ITALIA Tel. 02/55403211 Telefax 02/55401023	19/20

10. ADVERTÊNCIAS GERAIS ADICIONAIS

Instruções para a instalação e manutenção corretas

As instruções de utilização e manutenção encontram-se no Manual do Utilizador disponível no site:

www.eptarefrigeration.com.

As instruções de instalação destinadas ao pessoal especializados estão disponíveis:

- Junto da rede de assistência.
- Em algumas categorias de produto em papel entregue junto com o produto.

Serviços profissionais de reparação

Os serviços são distribuídos pela nossa rede de assistência que pode ser consultada na área dos contactos no endereço web www.eptarefrigeration.com.

Peças sobresselentes

As peças sobresselentes e as informações para a reparação do aparelho estão disponíveis por pelo menos 8 anos depois do produto ter sido declarado fora de produção, no seguinte endereço web: www.epta-service.com/service. As credenciais de acesso são fornecidas a pedido a remeter por email para: servicesupport@eptarefrigeration.com.

Limpeza do condensador

Os equipamentos com grupo incorporado com condensação de ar mantêm a sua eficiência apenas se a limpeza do condensador for efetuada da forma e dentro do tempo especificado no manual de utilização e manutenção.

Informação importante sobre os desperdícios de alimentos

Recomenda-se seguir com atenção as instruções de conservação indicadas nas embalagens dos produtos e as indicações fornecidas pelos produtores de alimentos.

Portanto, as seleções da temperatura devem ser adequadas às características de conservação dos produtos alimentares de acordo com as indicações que constam da nossa documentação técnica.

Utilizações não corretas podem causar deterioração.

Condições ambientais

O presente aparelho foi projetado para funcionar em ambientes em que a temperatura e a humidade não excedem os limites previstos no Manual de utilização e manutenção.

Instruções para a desembalagem

Para a desembalagem é necessário dirigir-se a operadores profissionais.

O grupo Epta, desde sempre animado por uma atenção especial para o ambiente, coloca ao dispor dos utilizadores os manuais de desmantelamento e tratamento dos resíduos dos balcões frigoríficos plug-in, cujo download pode ser feito a seguir.

- Manual de eliminação de balcões plug-in abertos:



- Manual de eliminação de balcões plug-in fechados:



Outras informações

Para maiores e detalhadas informações remeter-se a www.eptarefrigeration.com e à EPREL à qual se acede através do código QR presente ou na etiqueta energética do produto.



Modello - Modèle - Model Modell - Modelo - Modelo	GRANSESIA	COSTAN <small>eptarefrigeration</small>
Fabbricante - Constructeur - Manufacturer Hersteller - Fabricante - Fabricante	Epta Spa - Via Mecenate, 86 - 20138 Milano (MI) ITALIA Tel. 02/55403211 Telefax 02/55401023	20/20

IT

Limites de aplicação

FR



Este balcão foi projetado para a utilização, transporte e armazenamento até uma altitude máxima de 2000 m sobre o nível do mar.

EN

DE

Armazenagem:

- Temperatura entre 15°C e 50°C.
- Humidade relativa entre 20% e 90%.
- Tempo máximo 6 meses.

ES

PT

Transporte:

- Temperatura entre 20°C e 70°C.
- Humidade relativa entre 20% e 90%.
- Tempo máximo 2 meses.

Instalação:

- Temperatura entre 0°C e 40°C.
- Humidade relativa entre 20% e 90%.
- Tempo máximo 2 meses.

Utilização:

Os desempenhos do balcão não são garantidos para além da sua utilização normal. É garantida a sua integridade e segurança dentro dos seguintes limites para condições temporárias.

Ambiente no exterior do balcão:

- Da classe 1 (16°C / 80%rh) à classe 4 (30°C / 55%rh) ou à classe 6 (27°C / 70%rh).

Ambiente interior ao balcão (condições para a segurança elétrica):

Balcão a uma temperatura positiva

- Temperatura entre -10°C e +10°C.
- Humidade relativa entre 70% e 100%.
- Tempo máximo 10 anos.

Balcão a uma temperatura negativa

- Temperatura entre -40°C e 15°C.
- Humidade relativa entre 90% e 100%.
- Tempo máximo 10 anos.



Durante o funcionamento das resistências poderiam ocorrer localmente temperaturas superiores aos limites acima indicados, embora respeitando as condições de segurança.

Modello - Modèle - Model Modell - Modelo - Modelo	GRANSESIA	COSTAN eptarefrigeration
Fabbricante - Constructeur - Manufacturer Hersteller - Fabricante - Fabricante	Epta Spa - Via Mecenate, 86 - 20138 Milano (MI) ITALIA Tel. 02/55403211 Telefax 02/55401023	21/24

IT

FR

EN

DE

ES

PT

Modello - Modèle - Model Modell - Modelo - Modelo	<h1>GRANSESIA</h1>	
Fabbricante - Constructeur - Manufacturer Hersteller - Fabricante - Fabricante	Epta Spa - Via Mecenate, 86 - 20138 Milano (MI) ITALIA Tel. 02/55403211 Telefax 02/55401023	22/24

- IT
- FR
- EN
- DE
- ES
- PT

Modello - Modèle - Model Modell - Modelo - Modelo	<h1>GRANSESIA</h1>	
Fabbricante - Constructeur - Manufacturer Hersteller - Fabricante - Fabricante	Epta Spa - Via Mecenate, 86 - 20138 Milano (MI) ITALIA Tel. 02/55403211 Telefax 02/55401023	23/24

- IT
- FR
- EN
- DE
- ES
- PT

COSTAN 
eptarefrigeration
www.costan.com

Epta
Advanced Solutions
for your Store

Epta S.p.A. participates in the ECC programme for:
Refrigerated display cabinets (RDC). Check ongoing validity
of certificate online: www.eurovent-certification.com

EN ISO 9001
DE EN ISO 9001
EN ISO 14001
DE EN 14001
DIN EN 14001
EN ISO 14001



www.eptarefrigeration.com