

Refrigerated display cabinets

SV8 PI 60 140 C

SV8 PI 60 140 C GD

SV8 PI 90 140 C

SV8 PI 90 140 C GD

SV8 PI 60 140 F GD

SV8 PI 60 140 FC GD

SV8 PI 120 140 C GD 45R

SV8 PI 120 140 C GD 45L

Installation and Operating
Instructions EN



Before starting work on the refrigeration unit, please observe the following instructions:

Keep these instructions in a safe place and available for other users. They explain how to install, place, use and service the cabinet correctly and safely.

The cabinet must be installed and started up in compliance with the manufacturer's instructions and in conformance with local instructions and regulations.

If a defect occurs in the cabinet or cabinet equipment, or the cabinet does not operate normally, check that this does not create a hazard to people or property. If necessary, disconnect the cabinet and contact the nearest service organisation.

All users of the cabinet must be aware of how to use the cabinet correctly and safely. Our guarantee obligations are void in the event of non-compliance

General notice (liability): the information in this technical document is provided for description purposes. Guarantees regarding existence of certain properties or purposes mentioned always require prior written consent.

Contents

| | | | |
|----------|--|-----------|--|
| 1 | Description | 7 | Interruptions in electricity distribution |
| 2 | General information | 8 | Troubleshooting |
| 2.1 | Extract from our warranty terms | 9 | Servicing and spare parts |
| 2.2 | Standards and regulations | 10 | Decommissioning of SV8 |
| 2.3 | Cautions | 11 | Disposal of SV8 |
| 2.4 | Restrictions | 12 | Product information |
| 2.5 | Transport | 13 | General view |
| 2.6 | Delivery conditions of SV8 cabinets | 14 | Temperature performance |
| 2.7 | Unpacking and handling | 15 | Drawings |
| 2.8 | Requirements for the installation space / intended use | 15.1 | Electrical circuit diagram for SV8 PI 60 140 C, SV8 PI 60 140 C GD |
| 2.9 | Cleaning before use | 15.2 | Electrical circuit diagram for SV8 PI 90 140 C, SV8 PI 90 140 C GD |
| 3 | Identifying the equipment | 15.3 | Electrical circuit diagram for SV8 PI 60 140 F GD, SV8 PI 60 140 FC GD |
| 4 | Electrical connections | | |
| 5 | Operation | | |
| 5.1 | Starting up | | |
| 5.2 | Loading cabinet | | |
| 5.3 | Dixell XRB70CH control device | | |
| 5.3.1 | Display messages | | |
| 5.3.2 | Checking temperature settings | | |
| 5.3.3 | Defrosting | | |
| 5.3.4 | Error Messages | | |
| 5.3.5 | SV8 PI 60 140 FC GD | | |
| 5.4 | Energy savings | | |
| 5.5 | Setting SV8 shelves | | |
| 6 | Cleaning and maintenance of SV8 | | |
| 6.1 | Cleaning condenser | | |

1 Description

SV8 cabinets are refrigerated display cabinets for drinks, sandwiches and dairy products, aimed at impulse buyers. The cabinets maintain the storage temperature required by the products.

Versions:

SV8 PI XX YY A B C

(for example, SV8 PI 60 140 FC GD)

SV: Semi vertical

PI: Plug-in cabinet

XX: Length of the cabinet in cm

YY: Height of the cabinet in cm

A: Mode of operation

(**C** - Chiller, **F** - Freezer, **FC** - switchable Freezer / Chiller)

B: Type

(**None** - Open, **ECO** - ECO frame, **GD** - Glass door,

SGD - Sliding glass door)

C: For corner cabinets only

(**45L** = 45° Left, **45R** = 45° Right)

The cabinets are designed for ambient conditions that shall not exceed **climate class 3**:

- Relative humidity 60 % RH
- Ambient temperature +25 °C
- Frontal airflow < 0.2 m/s

The cabinets are manufactured by

Aste Finland Oy

Koskivuorenkatu 5,

30420, Forssa, Finland.

2 General information

2.1 Extract from our warranty terms

The warranty period is 1 year. The warranty claim starts on the day of the delivery, which is to be verified by the delivery note or invoice. Malfunctions that can be attributed to poor workmanship or material defects, will be rectified free of charge within the warranty period.

Further claims, in particular for consequential damages are excluded.

We shall assume no warranty for damages resulting from improper or inappropriate use, faulty installation or commissioning by the purchaser or third party, natural wear and tear, faulty or negligent handling, chemical or

electrochemical and electrical impacts, provided that they cannot be attributed to our fault, failure to observe the installation, operating, and maintenance instructions, improper modifications or repair work by the purchaser or third party, and effects of parts of external origin.

The warranty shall also expire if the refrigerant circuit has been opened by unauthorized persons, interventions in the system structure have been made, or the serial number on the device has been changed or made unrecognisable.

The warranty does not extend to any breakage of glass, accidental or otherwise.

2.2 Standards and regulations

SV8 refrigerated display cabinet was built and tested in accordance with the standards and regulations in force at the time of manufacture.

It corresponds to the:

Machinery Directive 2006/42/EC

Ecodesign Directive 2009/125/EC

Low Voltage Directive 2014/35/EU

Electromagnetic Compatibility Directive 2014/30/EU

RoHS Directives 2011/65/EU & 2017/2102/EU

WEEE Directive 2012/19/EU

Commission Regulation (EU) 2019/2024 regarding ecodesign requirements for refrigerating appliances with a direct sales function

Commission Regulation (EU) 2019/2018 regarding energy labelling of refrigerating appliances with a direct sales function

ISO 12100:2010

ISO 23953-1:2015, ISO 23953-2:2015

IEC 55014-1:2021, IEC 55014-2:2021

IEC 60335-1:2020, IEC 60335-2-89:2022

IEC 60730-1:2022

IEC 61000-3-2:2019, IEC 61000-3-3:2013

A-weighted emission sound pressure level of all cabinets is below 60 db(A)

2.3 Cautions



Caution. Flammable Material!

The symbol marked on the cabinet (a flame inside a triangle) indicates that the cabinet contains flammable coolant. The type of the coolant is stated in the same symbol attached to the cabinet.



Caution!

If the machinery contains propane R290, there is a fire hazard. The propane content is declared on the rating plate and the machinery.



Caution!

Do not store explosive substances such as aerosol cans with a flammable propellant in this cabinet.



Caution!

Do not obstruct airflow within the machinery and the cabinet.



Caution!

Do not hasten defrosting by mechanical or any other means not specified in these instructions.



Caution!

Do not damage the refrigeration circuit. Do not install the cabinet in an explosive environment. Do not install the cabinet in fire-hazardous areas.



Caution!

Due to fire hazard, only a qualified technician is allowed to install the system.



Caution!

No electrical equipment should be placed inside the cabinet unless specifically approved by the manufacturer.



Caution!

In case of power cable damage, it must be immediately replaced by the authorised representative of **Epta**, the manufacturer or qualified specialist in order to avoid a hazard.



Caution!

This cabinet can be used by children aged from 8 years and above and persons with reduced physical, sensory, or mental capabilities or lack of experience and knowledge if they have been given supervision or instruction concerning use of the cabinet in a safe way and understand the hazards involved.



Caution!

Do not use the cabinet without protective lighting covers / reflectors under the handrails. If the lighting covers are damaged or missing, they must be replaced and installed without delay to rule out any risk of electric shock from the lighting components. Using the product with lighting covers in place is perfectly safe.



Caution!

Children shall not play with the cabinet.

2.4 Restrictions

Using the cabinet in any way other than specified in these instructions is prohibited. Only products that are specified in these instructions or in the brochure for the cabinet may be stored in the cabinet.

The manufacturer accepts no liability for incidents that are caused by using the cabinet in contravention of these instructions, or with disregard for the warnings in these instructions or without following these instructions.



Note:

Climbing inside or on the top of the cabinet is prohibited. Standing on any part of the cabinet is prohibited.



Note:

Handle cabinets with glass lids and doors with care to avoid finger or other injuries.



Note:

Cabinet is for indoor use only.



Note:

Ventilate the premises if refrigerant leakage is suspected.



Note:

Disconnect the cabinet from the power supply before replacing the source of light.



Note:

Storing flammable or hazardous liquids in the cabinet is strictly prohibited.

2.5 Transport

Due to the oil in the compressor, the cabinet may only be transported in the operating position. Only the original packaging may be used for any further transport.

SV8 cabinets use flammable refrigerant: do not turn on the power to the cabinet if you suspect that a refrigerant leakage has occurred during transportation.

2.6 Delivery conditions of SV8 cabinets

SV8 cabinet is delivered ready for operation and wired ready to plug in transported on a pallet and packed in protective wrap.

2.7 Unpacking and handling

- Before and when unpacking the cabinet, a visual inspection must be carried out to detect any damage that may have been caused during transport.
- Please pay attention to loose parts, dents, scratches, visible oil loss, etc.
- Before the packaging material is disposed of, it must be checked whether it still contains loose parts.
All packaging materials are recyclable.
- For processing warranty claims, please provide us with precise details of the fault (with photo where applicable), as well as the type designation and serial number of the cabinet.
- To protect the cabinet from damage, it must only be transported and stored in the operating position. It must be ensured that the evaporator and condenser are not damaged. Failure to do so will void the warranty.

2.8 Requirements for the installation space / intended use

The cabinet is designed for free intake and discharge out of air. Leave an unobstructed air gap of at least 10 cm, behind the cabinet, 20 cm when cabinets are back-to-back, and of at least 25 cm above the cabinet.

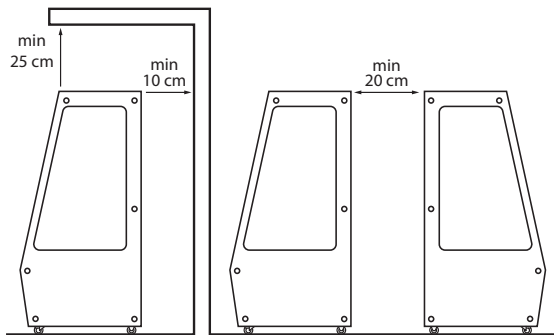

When installing the cabinet, make sure of the following:

- The area where the cabinet is placed is flat and level.
- No objects are placed on top of the cabinet.
- The cabinet is not placed in the immediate vicinity of a heat source such as a radiator, air blown heater or spotlight.
- The cabinet is not exposed to direct sunlight. If necessary, use blinds in any nearby window.
- The air conditioning for the premises does not blow onto the cabinet.

The correct positioning of the cabinet optimises temperature conditions and performance.

Cabinets with castors / wheels may be anchored to the wall behind them as a safety precaution.

2.9 Cleaning before use

1. Clean the cabinet surfaces and the storage compartment for foodstuffs with a mild liquid detergent (pH 6-8) before using the cabinet.
Follow the instructions provided with the detergent.
Make sure that all cleaning fluids are classed as non-toxic.
2. Dry the surfaces carefully.

3 Identifying the equipment

Find the label affixed on the back of storing compartment as shown in *Section "General view"* to read the technical data.

Check the cabinet model and the power supply voltage before you perform any operation.

If discrepancies are found, contact the manufacturer or the company that offers the supply immediately.

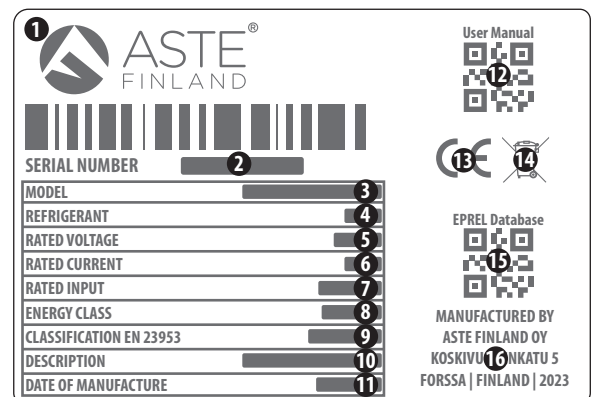

1. Identification of the company responsible for the product
2. Serial no.
3. Model name
4. Type and weight of coolant
5. Rated voltage
6. Rated current
7. Rated input
8. Energy class
9. Product class
(see *Section "Temperature performance"*)
10. Type
11. Date of manufacture
12. User manual QR-code
13. Symbols of compliance
14. WEEE mark
15. EPREL database QR-code
16. Manufacturer

4 Electrical connections



The symbol marked on the cabinet (a lightning bolt inside a triangle) indicates that there are components and wires under the cover containing live voltage.

Only personnel qualified to install and service electrical equipment are permitted access to areas that contain live voltage.

Check the voltage and size of the fuse required on the rating plate attached to the cabinet. The supply socket must be earthed and protected by a 10 A slow fuse. No other appliances may be connected to the same fuse.

All electrical connections must be carried out by approved and qualified personnel and comply with all IEE, local regulations and the connection conditions of the respective power supply company, failure to do this could result in personal or fatal injury.

5 Operation

Cooling is achieved by a fan evaporator system. The evaporator is located at the bottom of the cabinet's tray. Cold air is blown inside through the perforated side wall.

The cabinet is equipped with Dixell XRB70CH controller.

5.1 Starting up

1. Connect the plug to the supply socket.
The compressor and fans start operating.
2. Wait for 90 minutes or until the desired temperature is reached.
The cabinet is now ready to be filled.

Do not load Freezer cabinet before the temperature display reads -18 °C.

5.2 Loading cabinet

Position the products carefully.

Do not exceed the load limit. (see Section "Cabinet load").

- The maximum load on the shelves is 120 kg/m².
- The maximum load on the bottom layer is 400 kg/m².

Do not place products so that they protrude over the front edge of the shelf or obstruct the inlet grid.

Do not fill the cabinet above the load limits marked in the cabinet. 

Exceeding the load limit will disrupt the designed airflow pattern and cause the temperature of products to rise.

Do not drop or throw products into the cabinet.



Note:

The cabinet is not designed to cool down products but to maintain them at the temperature at which they are placed in the cabinet. Food products warmer than the specified temperature should not be placed in the cabinet.

5.3 Dixell XRB70CH control device

The operating thermostat for the cabinet is located in the panel at the bottom of the cabinet's front part behind the ventilation grating. The thermostat can be accessed through an opening in the grating.

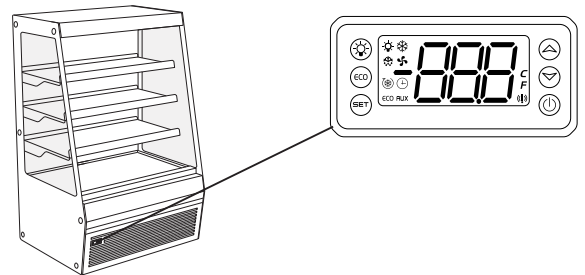



The thermostat is preset to the correct temperature at the factory.



XRB70CH is a cabinet controller that directs the cabinet functions and defrosting by means of temperature sensors. Please note that the type of the control device depends on the cabinet. All features are not available on every cabinet.

5.3.1 Display messages

In normal status, the display shows cabinet temperature.

5.3.2 Checking temperature settings

Press and hold  for 3 (three) seconds, then press  to display target set point and the real set point.

Select the desired target temperature by pressing  or . Then press .

Turn lights ON/OFF by pressing .

The normal temperature view also reappears if you do not touch any button for five (5) seconds.

Press  to switch the cabinet on and off.

5.3.3 Defrosting

Start defrosting by pressing .
Thawing is fully automatic.

5.3.4 Error Messages

Overheat alarm signal

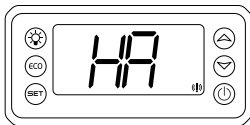

The compressor is switched off due to overheating. Check that the door (if present) is firmly closed, the cabinet is not exposed to the heat or sunlight.

Check that the airflow (both inlet and outlet) is not obstructed. Check that the ambient conditions correspond to the required ones.

If the fault persists, contact service.

Low temperature alarm signal

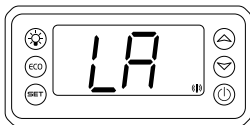

Probe failure, contact service.

5.3.5 SV8 PI 60 140 FC GD

SV8 PI 60 140 FC GD cabinet is equipped with the switch enabling Chiller ("C") or Freezer ("F") modes.

To change between modes:

1. Switch off the cabinet (see Section "Checking temperature settings").
2. Keep the cabinet turned off for 24 hours.
3. Clean the cabinet if needed (see Section "Cleaning and maintenance of SV8").
4. Set the operation mode switch to desired mode by turning it clockwise or counterclockwise to "F" or "C" position.
5. Switch the cabinet on.

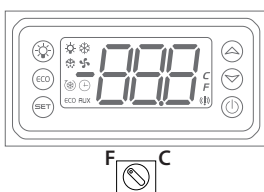

5.4 Energy savings

Avoid opening door (when present) for too long and unnecessarily.

Monitor storage temperature.

Clean the refrigeration unit regularly. A clean device saves energy and has a longer service life.

Observe cleaning intervals (see Section "Cleaning and maintenance of SV8"). Regular maintenance increases the service life.

SV8 C and C ECO models include a night blind that can be pulled in front of the shelves. Pull the night blind up as shown in the picture and lock the hook in the counterpart, which is found at the bottom of cabinet's roof.

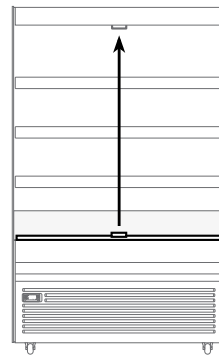

5.5 Setting SV8 shelves

The display shelves of SV8 SU shop fitting, SV8 60 140 and SV8 90 140 cabinets, can be set to two positions: straight (fig 1) and 10° inclined (fig 4).

The following pictures illustrate how to change shelf position.

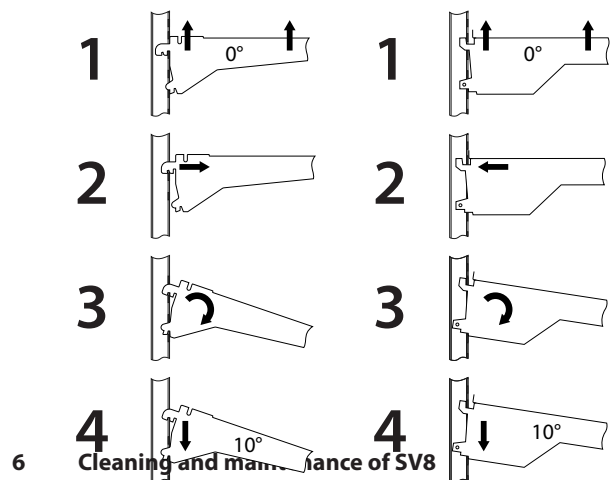

SV8 cabinets are maintenance-free, however, it is advised to clean the cabinet depending on the installation location and the degree of pollution level.



Caution!

When conducting cleaning and maintenance work, always unplug the mains plug from the socket and secure it against being plugged in again.



Caution!

Evaporators, condensers and parts made of steel may have sharp edges. Wear protective gloves and work cautiously to avoid cut injuries.

Do not spray-clean the cabinet with water or steam!

1. Disconnect the cabinet from the mains supply.
2. Empty the cabinet.
3. Allow the cabinet to reach the ambient temperature.
4. Remove any debris.

Do not use picks or sharp tools to remove ice from the evaporator damage to the coil may lead to refrigerant leakage.

The thin fins must also not be crushed or damaged during cleaning work.

5. Inspect for drain water and remove it, if there is any.
6. Clean the interior surfaces of the cabinet with a mild liquid detergent (non-toxic, pH 6-8) and dry the surfaces carefully using a clean towel.
7. When cleaning is completed, start up the cabinet.
8. See Section "Starting up".
9. Check at regular intervals also that
 - the operating noise of the cabinet is normal,
 - the evaporator is clean and
 - the inlet and outlet grids are not obstructed or dirty.
10. SV8 cabinets should be periodically checked and, if necessary, cleaned after commissioning.

The time until the next inspection or cleaning process must be determined depending on the level of dirt.



Note:

Clean the drain sump located in the machinery compartment. Inadequate or infrequent cleaning may shorten the service life of the electric heater / hot gas piping for the drain sump. Detergent residues must be cleaned without delay from the tray.



Note:

In the event of a refrigerant leakage all products displayed in the cabinet must be disposed of and then the cabinet must be cleaned.

6.1 Cleaning condenser

The cabinet is equipped with maintenance-free condenser.

It is advised to clean the condenser at least once a year or more often depending on the installation location and the degree of pollution level.

1. Remove the front grill by pulling it up and outwards.
2. Clean condenser fins with a brush or vacuum cleaner and check that the spaces between the fins are unobstructed.
3. **Place the front grill back and make sure it is positioned properly.**



Note:

When the cabinet is disconnected from the mains supply, the sump heater or pump will not operate and drain water or cleaning liquid may fill the evaporation sump.

7 Interruptions in electricity distribution

The cabinet will start up automatically after a power cut or an interruption in the electricity supply. The evaporation drain sump may overflow during a power cut.

After a power cut, check that the cabinet operates normally.

If necessary, contact your nearest service organisation.

8 Troubleshooting

If a defect occurs in the cabinet or cabinet equipment, or the cabinet does not operate normally, check that this does not create a hazard to people or property. If necessary, disconnect the cabinet and contact your nearest service organisation.

Before contacting a service representative, check that:

- the plug has not come out of the supply socket,
- that the mains supply is working,
- the fuse for the cabinet is intact,
- the cabinet is correctly positioned,
- the condenser is not blocked or dirty,
- the products are placed in the cabinet correctly,
- the airflow in the cabinet is not disrupted,
- defrosting is not in progress, see the thermometer.

If the reason for the malfunction cannot be identified, disconnect the electrical supply to the cabinet and contact the service organisation.

Check at regular intervals that the operating noise of the cabinet is normal, the condenser and evaporator are clean, and the air flow through the inlet and outlet grids is not obstructed by debris, packaging waste or other such material.

9 Servicing and spare parts

The specifications of the cabinet are marked on the rating plate (see Section "Identifying the equipment"). Please inform your authorised service organisation of the cabinet type, name, serial number and the Control markings marked on the rating plate.

The wiring diagram and the rating plate are located behind the front grill close to the thermostat (see Section "General View").

The service periods of the cabinet are defined in a service contract.



Note:

Only authorised fitters may carry out servicing and repair of the machinery and electrical equipment in the cabinet. The evaporator should be cleaned by authorised service personnel.

It is recommended to use **Epta** spare parts.

The minimum period during which spare parts, necessary for the repair of the cabinet is 8 years after placing the last unit of the model on the market.



Note:

All information related to the spare parts can be found at www.shop.vkag.de

10 Decommissioning of SV8

In case of prolonged standstill or maintenance and cleaning work, the cabinet must be taken out of operation by disconnecting the mains plug.



Caution!

If the cabinet is taken out of operation and stored in a frost-endangered area, it must be ensured that the cabinet is cleaned and water of the heat exchanger is completely drained, otherwise it can be destroyed.



Caution!

Remove the door (if present) or position the standstill cabinet so that no person can climb inside and get locked up.

11 Disposal of SV8

If the cabinet has to be replaced with a new one, ensure that its pipes are not damaged so that no refrigerant can escape.

End-of-life, faulty cabinets or refrigerant that has been suctioned out must be disposed of in an environment-friendly manner under consideration of the applicable provisions.

Seek expert advice when disposing of substances that are harmful to the environment and when utilising recyclable material.



Caution!

R290 is highly flammable, this applies to cabinets using R290 propane as refrigerant.

12 Product information

Product information can be retrieved from European product database (EPREL).

1. Remove the ventilation grating covering the rating plate.
2. Read the QR code on the rating plate to retrieve the product information from EPREL

or

Access EPREL via <https://eprel.ec.europa.eu/> and use the model ID provided in the rating plate to find the product information.



Note:

Detailed product information, recommendations for optimal temperature for food and beverage preservation, and more documentation can be found at www.eptarefrigeration.com

13 Cabinet load

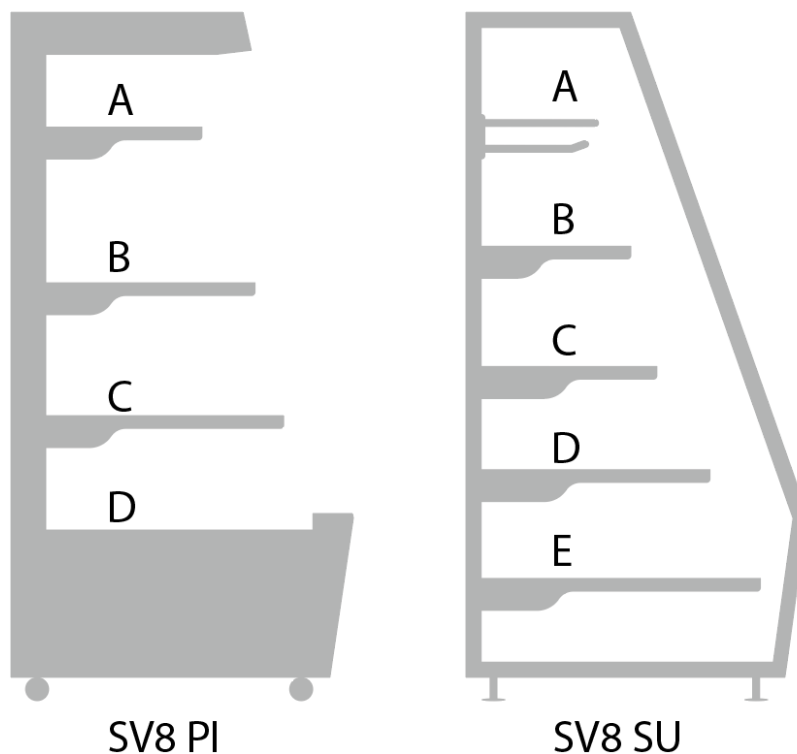

The following table provides maximum loads for SV8 PI cabinets and SV8 SU shop fitting.

| Product | A | B | C | D | |
|--------------------------|-----------|--------------|------------------|--------------|--------------|
| SV8 PI | Top Shelf | Second Shelf | Additional Shelf | Bottom Layer | |
| SV8 PI 60 140 C | 24 kg | 29 kg | 33 kg | 42 kg | |
| SV8 PI 60 140 FC | 20 kg | 24 kg | | 25 kg | |
| SV8 PI 90 140 | 36 kg | 44 kg | 51 kg | 63 kg | |
| SV8 PI 120 140 C GD 45RL | 29 kg | 38 kg | | 56 kg | |
| SV8 SU | Hook | Top Shelf | Second Shelf | Third Shelf | Bottom Shelf |
| SV8 SU 93 140 D | 15 kg | 67 kg | 89 kg | 89 kg | 112 kg |
| SV8 SU 93 140 E | | | | | |
| SV8 SU 93 140 F | | | | | |
| SV8 SU 153 140 G | | | | | |

14 General view

- | | |
|--|-----------------------------------|
| 1. Dixell control device | 8. Shelf with horizontal lighting |
| 2. Front grill with condenser behind | 9. 40mm price tag rail |
| 3. Rating plate (behind the front grill) | 10. Horizontal lighting |
| 4. Wheels | 11. Warm air outlet |
| 5. Cooling air intake | 12. Rear grill |
| 6. Bottom shelf | 13. Power cable with power plug |
| 7. Return air grill | |

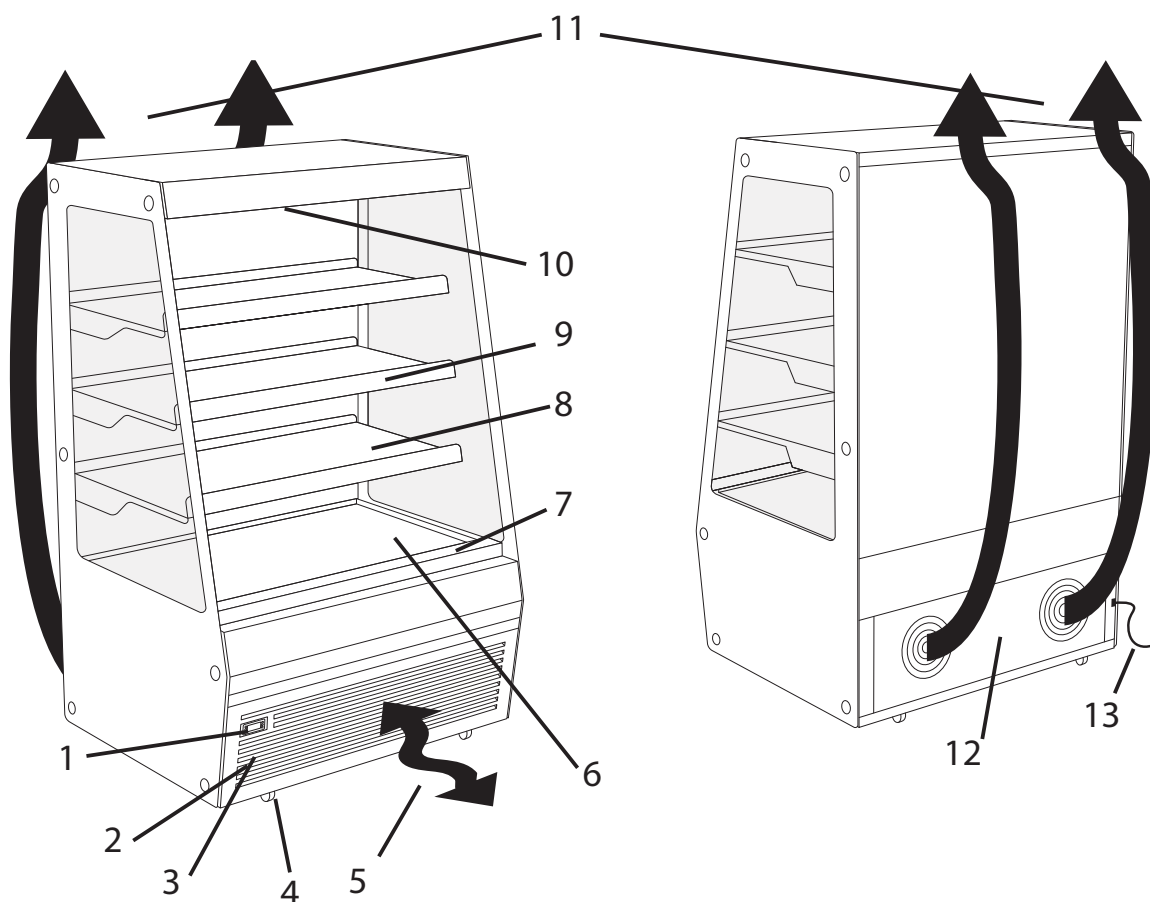

15 Temperature performance

The product class stated in the rating plate describes the product storage temperatures for the cabinet.

| Climate Class | 3 (25°C / 60% Rh) | | | |
|----------------------|--|---------------------------------------|---------------------------------|--------------------------------|
| Temperature Class | M0 | M1 | M2 | L1 |
| Storage temperature | -1°C...+1°C | 0°C...+2°C | +2°C...+4°C | -21°C...-23°C |
| Product temperature | -1°C...+4°C | -1°C...+5°C | -1°C...+7°C | -15°C...-18°C |
| Field of application | Venison, Poultry, Meat, Convenience, Dairy, Beverage | Meat, Convenience, Dairy, Beverage | Convenience, Dairy, Beverage | Deep frozen food, Ice Cream |

16 Drawings

16.1 Electrical circuit diagram for SV8 PI 60 140 C, SV8 PI 60 140 C GD

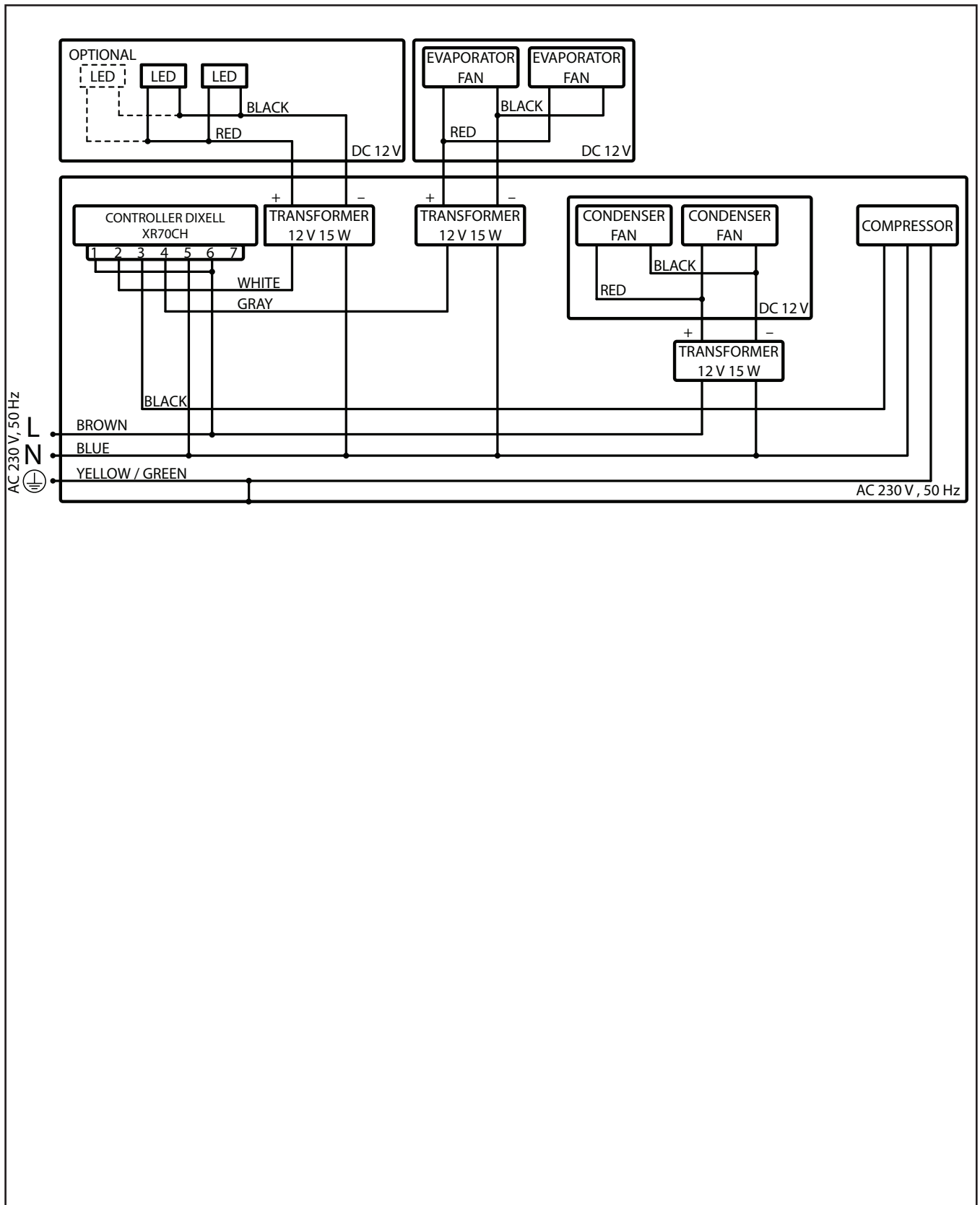

General notice (liability): the information in this technical document is provided for description purposes. Guarantees regarding existence of certain properties or purposes mentioned always require prior written consent.

16.2 Electrical circuit diagram for SV8 PI 90 140 C, SV8 PI 90 140 C GD

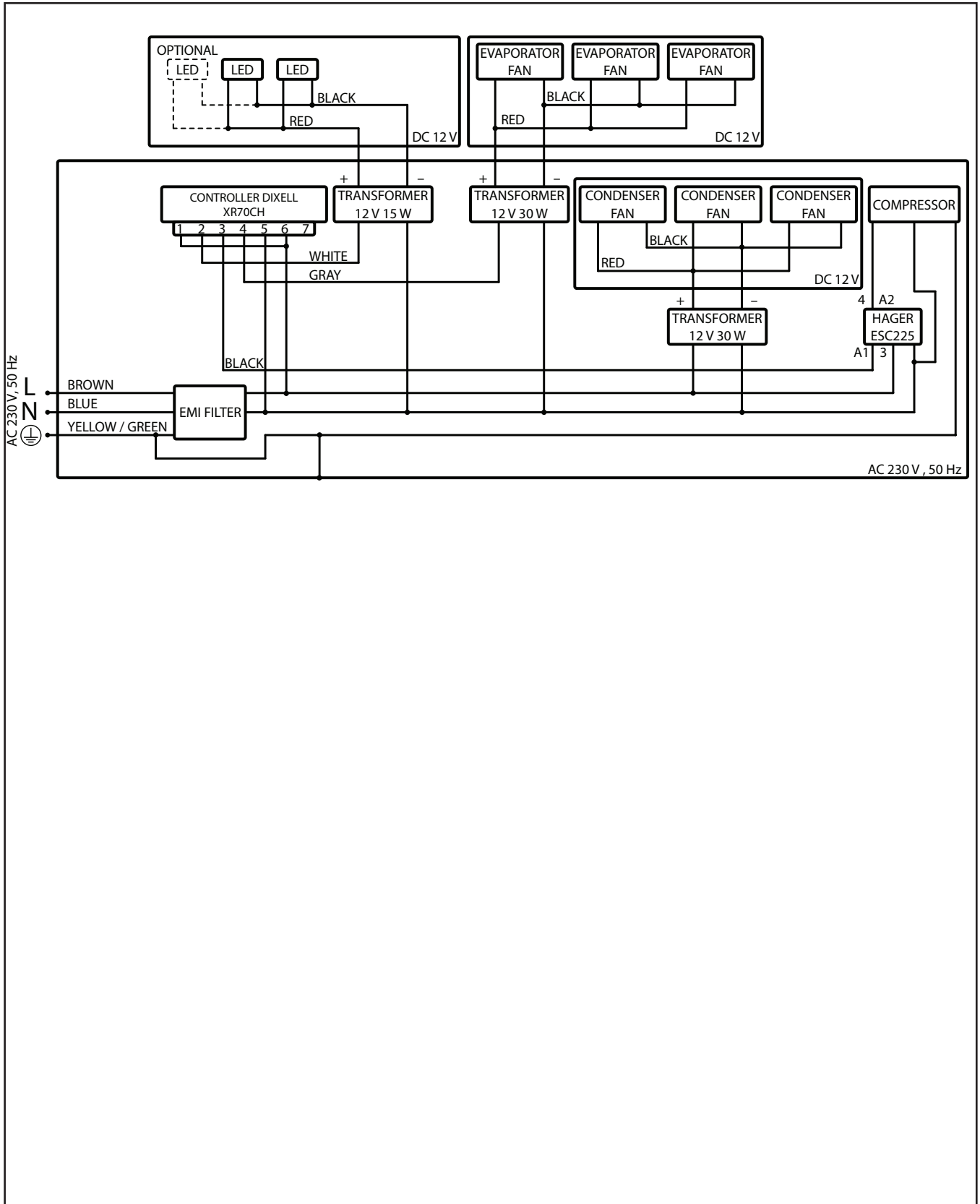

General notice (liability): the information in this technical document is provided for description purposes. Guarantees regarding existence of certain properties or purposes mentioned always require prior written consent.

16.3 Electrical circuit diagram for SV8 PI 60 140 F GD, SV8 PI 60 140 FC GD

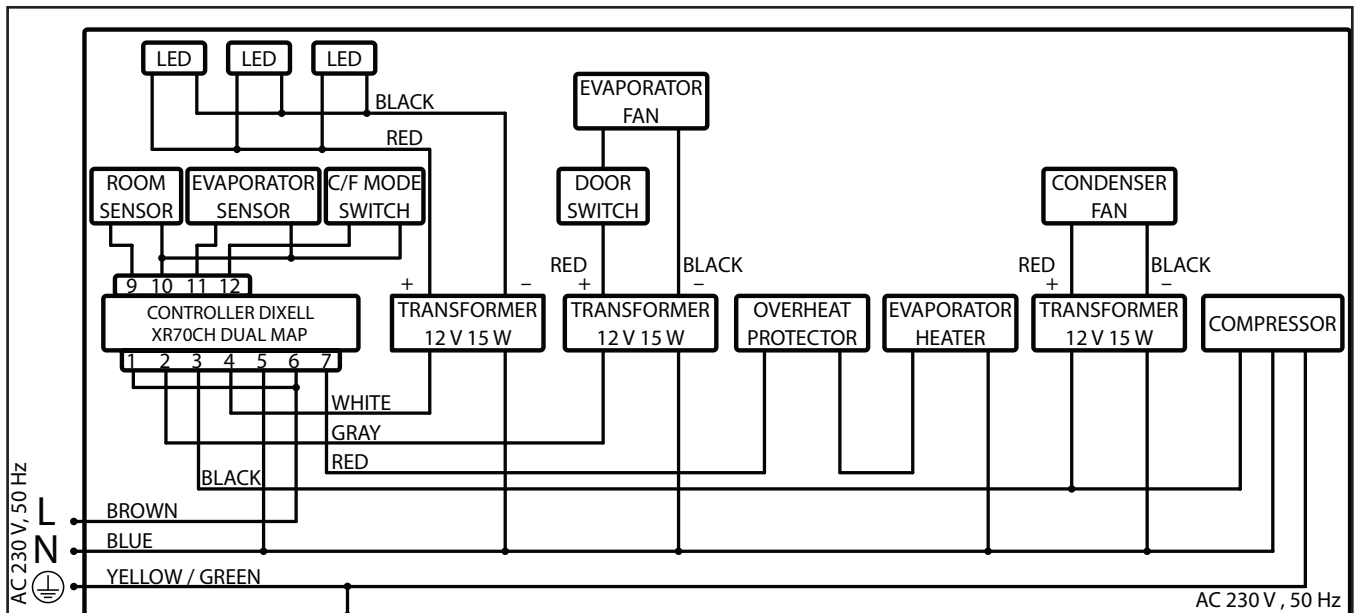

General notice (liability): the information in this technical document is provided for description purposes. Guarantees regarding existence of certain properties or purposes mentioned always require prior written consent.